

CONVEY-ALLTM

OPERATOR'S MANUAL



TRUCK LOAD CONVEYOR

1640-TL • 1650-TL • 1658-TL

**WARRANTY REGISTRATION FORM
and INSPECTION REPORT**

CONVEY-ALL™

Box 760, 275 Hespler Ave, Winkler, Manitoba R6W 4A8
T: (800) 418-9461 P: (204) 325-4195 F: (204) 325-8116
www.convey-all.com conveyors@convey-all.com

The Dealer must fill out this form, and be signed by both the Dealer and Buyer at the time of delivery. Scan or photograph the completed form (must be legible), and email it to: register@convey-all.com A copy of this form may also be mailed to the above address.

Buyer's Name _____	Dealer's Name _____
Address _____	Address _____
City _____	City _____
Province/State _____	Province/State _____
Postal Code/Zip Code _____	Postal Code/Zip Code _____
Country _____	Country _____
Phone Number _____	Phone Number _____
Unit's Model Number _____	Unit's Serial Number _____
Delivery Date _____	General Purpose: <input type="checkbox"/> Private <input type="checkbox"/> Commercial

UNIT INSPECTION

- All Fasteners Tight
- Engine/Hydraulic Fluid Levels Checked
- Hydraulic Hoses Good, Fittings Tight
- Machine and All Bearings Lubricated
- Conveyor Belt Aligned and Tensioned
- Conveyor Belt Moves Freely
- Conveyor Tube Raises and Lowers Smoothly
- Unit Steers and Drives Smoothly
- Tire Pressure Checked

SAFETY INSPECTION

- All Guards/Shields Installed and Secured
- All Safety Decals Clear and Legible
- Reflectors, Slow Moving Vehicle Sign are Clean
- All Lights are Clean and Working
- Safety Chain on Hitch
- Reviewed Operating and Safety Instructions

I have thoroughly instructed the buyer on the above described equipment. The review included the content of the Operator's Manual, equipment care, adjustments, safe operation and warranty policy.

Date _____ Dealer's Signature _____

The above equipment and Operator's Manual have been received by me. I have been thoroughly instructed as to care, adjustments, safe operation and applicable warranty policy.

Date _____ Buyer's Signature _____

This page intentionally left blank

TABLE OF CONTENTS

DESCRIPTION	PAGE
Section 1: INTRODUCTION	1-1
1.1 Operator Orientation	1-1
1.2 Serial Number	1-1
Section 2: SAFETY	2-1
2.1 Safety Orientation	2-2
2.2 General Safety	2-2
2.3 Equipment Safety Guidelines	2-3
2.4 Safety Decals	2-3
2.4.1 Applying Decals	2-3
2.5 Safety Decal Location	2-4
2.6 Work Preparation	2-5
2.7 Placement Safety	2-5
2.8 Lock-Out Tag-Out Safety	2-5
2.9 Maintenance Safety	2-6
2.10 Tire Safety	2-6
2.11 Battery Safety	2-6
2.12 Engine Safety	2-7
2.13 Operating Safety	2-8
2.14 Hydraulic Safety	2-8
2.15 Workplace Hazard Area	2-9
2.16 Transport Safety	2-10
2.17 Storage Safety	2-10
Section 3: OPERATION	3-1
3.1 Machine Components	3-2
3.2 Components and Controls	3-3
3.3 Machine Break-In	3-10
3.4 Pre-Operation Checklist	3-10
3.5 Attaching to Tow Vehicle	3-11
3.6 Conveyor Placement	3-12
3.7 Operating on Site	3-14
3.7.1 Starting Conveyor	3-14
3.7.2 Stopping Conveyor	3-14
3.7.3 Emergency Stopping	3-14
3.7.4 Restarting after Emergency Stop	3-15
3.7.5 Unplugging	3-15

continued on next page

TABLE OF CONTENTS

DESCRIPTION	PAGE
3.8 Operating Hints	3-16
3.9 Transportation	3-17
3.10 Storage.	3-19
Section 4: SERVICE AND MAINTENANCE	4-1
4.1 Fluids and Lubricants.	4-1
4.1.1 Greasing.	4-2
4.2 Servicing Intervals	4-2
4.2.1 After 10 Hours or Daily.	4-3
4.2.2 After 50 Hours or Weekly	4-4
4.2.3 After 100 Hours or Monthly	4-5
4.2.4 After 200 Hours or Annually.	4-6
4.3 Maintenance Procedures.	4-8
4.3.1 Conveyor Belt Tension	4-8
4.3.2 Conveyor Belt Alignment	4-9
4.3.3 Conveyor Belt Replacement	4-11
4.3.4 Change Hydraulic Oil	4-12
4.3.5 Change Hydraulic Oil Filter	4-12
4.4 Service Record.	4-13
4.5 Ordering Parts	4-14
Section 5: TROUBLESHOOTING.	5-1
Section 6: REFERENCE.	6-1
6.1 Specifications.	6-1
6.2 Working Measurements	6-1
6.3 Bolt Torque.	6-2
Warranty Statement	

Section 1: INTRODUCTION

Congratulations on your choice of a Convey-All™ Truck Load conveyor. It is designed to efficiently move grain, pulse crops or granular material between a storage facility and a truck and trailer.

Convey-All™ is a member of the Meridian Manufacturing Inc. family. The equipment we design and manufacture meet the exacting standards of the agricultural industry.

Keep this manual handy for frequent reference and pass it on to new operators or owners. Call your dealer, distributor or Meridian Manufacturing Inc., if you need assistance, information, additional/replacement copies, or a digital copy of this document.

Information provided herein is of a descriptive nature. Meridian Manufacturing Inc. reserves the right to modify the machinery design and specifications provided herein without any preliminary notice.

Performance quality may depend on the material being handled, weather conditions and other factors.

1.1 OPERATOR ORIENTATION

The directions; left, right, front and rear, as mentioned throughout this manual, are as seen from the tow vehicle driver's seat, facing the direction of travel. The hopper is the front of the conveyor.

1.2 SERIAL NUMBER

Always give your dealer the serial number when ordering parts, requesting service or asking for other information. The conveyor's serial number is located at the hopper.

Use the space provided for easy reference:

Conveyor Model No: _____

Conveyor Serial No: _____

Engine Model No: _____

Engine Serial No: _____



Fig 1 - Serial Number Location

This page intentionally left blank

Section 2: SAFETY

3 Big Reasons why safety is important to you:

- Accidents Disable and Kill
- Accidents Cost
- Accidents Can Be Avoided

The Safety Alert Symbol means:

The Safety Alert Symbol identifies important safety messages on the conveyor and in this manual.

The following signal words are used in this manual to express the degree of hazard for areas of personal safety.

When you see the symbol and/or the signal words described below, obey the accompanying message to avoid possible injury or death.

DANGER

Indicates a hazardous situation that, if not avoided, will result in death or serious injury. This signal word is limited to the most extreme situations. Typically for machine components which, for functional purposes, cannot be guarded.

WARNING

Indicates a hazardous situation, if not avoided, could result in death or serious injury. This word identifies hazards that are exposed when guards are removed. It may be used to alert against unsafe practices.

CAUTION

Indicates a hazardous situation, if not avoided, could result in minor or moderate injury. It may be used to alert against unsafe practices.

NOTICE

Indicates practices or situations which may result in the malfunction of, or damage to equipment.

SAFETY INSTRUCTIONS

Safety instructions (or equivalent) signs indicate specific safety-related instructions or procedures.

2.1 SAFETY ORIENTATION

YOU are responsible for the SAFE operation and maintenance of your Convey-All™ Truck Load conveyor. Be sure that everyone who will operate, maintain or work around it, is familiar with the safety, operating and maintenance procedures.

This manual will take you step-by-step through your working day. It will alert you to all the safe practices that should be adhered to while operating the conveyor.

It has been said, "The best safety feature is an informed, careful operator." Good safety practices not only protect you but also the people around you. Make these practices a dynamic part of your workday.

Most accidents can be prevented. Do not risk injury or death by ignoring good safety practices.

- Conveyor owners must give operating instructions to operators or employees before allowing them to operate the machine.

Procedures must be reviewed annually thereafter, as per OSHA (Occupational Safety and Health Administration) regulation 1928.57.

- The most important safety device on this equipment is a SAFE operator. It is the operator's responsibility to understand all safety and operating instructions in this document, and to follow them.
- An untrained operator exposes himself and bystanders to possible serious injury or death.
- Think SAFETY! Work SAFELY!

2.2 GENERAL SAFETY

- Read and understand the Operator's Manual and all safety decals before operating, maintaining, adjusting or unplugging the conveyor. 

- Only trained, competent persons shall operate the conveyor. An untrained person is not qualified to operate the machine.

- Have a first-aid kit available for use should the need arise. 

- Provide a fire extinguisher for use in case of an accident. Store in a highly visible place. 

- Do not allow riders.

- Do not allow children, spectators or bystanders within hazard area around the machine.

- Wear appropriate protective gear. This list may include but is not limited to:

- Hard hat
- Protective shoes with slip resistant soles
- Eye protection
- Work gloves
- Hearing protection
- Respirator or filter mask
- Hi-Visibility safety vest

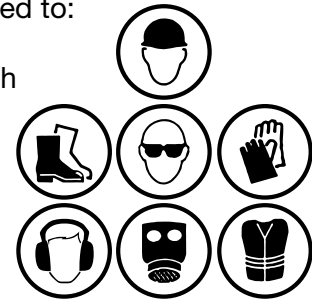

- Never use alcoholic beverages or drugs which can hinder alertness or coordination while operating this equipment.

Consult your doctor about operating machine while taking prescription medications.

- If the elderly are assisting with farm work, their physical limitations need to be recognized and accommodated.

- Review safety related items annually with all personnel who will be operating or maintaining the conveyor.

2.3 EQUIPMENT SAFETY GUIDELINES

- Safety of the operator and bystanders is one of the main concerns when designing and developing this conveyor. However, every year many accidents occur which could have been avoided by a few seconds of thought, and a more careful approach to handling equipment.
- Do not allow personnel to operate this unit until they have read this manual. They should have a thorough understanding of the safety precautions.

Review the safety instructions with all users annually.

- In order to provide a better view, certain photographs or illustrations in this manual may show an assembly with safety guards removed.

Equipment should never be operated in this condition. All guards must be in place. If removal becomes necessary for repairs, replace the guard prior to use.



- This equipment is dangerous to children and persons unfamiliar with its operation.

The operator must be responsible, properly trained and physically able. You should be familiar with farm machinery in general.

- Never exceed the limits of a piece of machinery. If its ability to do a job, or to do so safely, is in question - DO NOT TRY IT.
- Do not modify the equipment in any way. Unauthorized modification result in serious injury or death and may impair the function and life of the equipment.
- The design and configuration of this conveyor includes safety decals and equipment. They need to be clean, readable and in good condition.

2.4 SAFETY DECALS

- Keep safety decals clean/legible at all times.
- Replace safety decals that are missing or have become illegible.
- Replaced parts must display the same decal(s) as the original parts.
- All safety decals have a part number in the lower right hand corner. Use this part number when ordering replacements.
- Safety decals are available from your authorized distributor, dealer's parts department or from Meridian Manufacturing Inc.

2.4.1 Applying Decals:

1. Be sure the application area is clean and dry. Ensure the surrounding temperature is above 10°C (50°F).
 - Remove all dirt, grease, wax from the surface.
 - Clean with a non-ammonia based cleaner.
 - Wipe the clean surface with isopropyl alcohol on paper towel, and allow to dry.
2. Determine the exact position before you remove the backing paper.
3. Peel a small portion of the split backing paper.
4. Align the decal over the specified area. Use a squeegee to carefully press the small portion, with the exposed adhesive backing, into place.
5. Slowly peel back the remaining paper and carefully smooth the rest of the decal into place.
6. Small air pockets can be pierced with a pin and smoothed out using the squeegee, or a piece of sign backing paper.

2.5 SAFETY DECAL LOCATION

The following illustration show the general location of safety decals on this conveyor. The position of decals may vary depending on the machine's options. Decals are not shown at actual size.

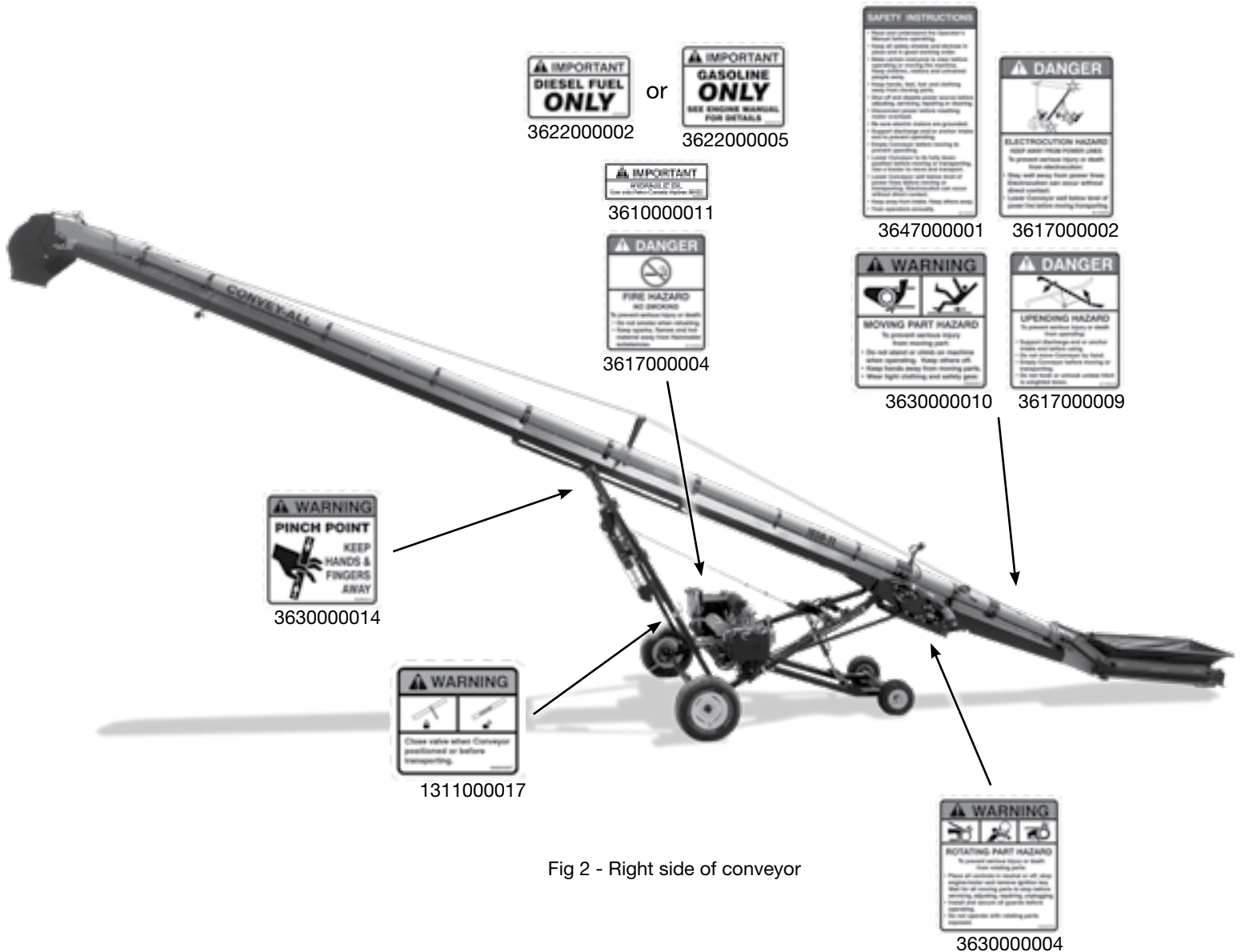

Fig 2 - Right side of conveyor

REMEMBER - If safety decals have been damaged, removed, become illegible, or parts were replaced without signage, new ones must be applied. New decals are available from your authorized dealer.

2.6 WORK PREPARATION

- Never operate the conveyor and its engine until you have read this manual, and understand the information.

Also, read the engine operator's manual.

- Be familiar with the safety messages found on the decals around this unit.

- Personal protective equipment (PPE) include:

- Hard hat
- Eye protection
- Protective shoes
- Work gloves



They are recommended during installation, placement, operation, maintenance and removal of the equipment.

- Do not allow long hair, loose fitting clothing or jewelry to be around equipment.
- **PROLONGED EXPOSURE TO LOUD NOISE MAY CAUSE PERMANENT HEARING LOSS!**

Agricultural equipment can often be noisy enough to cause permanent, partial hearing loss. We recommend that you wear hearing protection on a full-time basis if the noise in the Operator's position exceeds 80 db.



Noise over 85 db on a long-term basis can cause severe hearing loss.

Noise over 90 db adjacent to the operator over a long-term basis may cause permanent, total hearing loss.

Note:

Hearing loss from loud noise (tractors, chain saws, radios, etc.) is cumulative over a lifetime without hope of natural recovery.

- Clear working area of stones, branches or hidden obstacles that might be hooked or snagged, causing injury or damage.
- Operate only in daylight or good artificial light.
- Be sure machine is in a stable position, is adjusted and in good operating condition.
- Ensure that all safety guards and safety decals are properly installed and in good condition.
- Before starting, inspect the unit for any loose bolts, worn parts, cracks, leaks or frayed belts. Make the necessary repairs.

Always follow the maintenance instructions.

2.7 PLACEMENT SAFETY

- Stay away from overhead power lines when operating or moving the conveyor. Electrocutation can occur without direct contact.
- Keep conveyor as low as possible.
- Chock conveyor wheels before operating.
- Position conveyor providing enough space for trucks to load or unload.
- Operate conveyor on level ground, free of debris.

2.8 LOCK-OUT TAG-OUT SAFETY

- Establish a formal Lock-Out Tag-Out program for your operation.
- Train all operators and service personnel before allowing them to work around the area.
- Provide tags on the machine and a sign-up sheet to record tag-out details.

2.9 MAINTENANCE SAFETY

- Review Section 4: Service and Maintenance, before maintaining or operating the conveyor.
- Follow good shop practices:
 - Keep service area clean and dry.
 - Be sure electrical outlets and tools are properly grounded.
 - Use adequate light for the job.
- Place all controls in neutral or off. Stop engine, and remove ignition key. Wait for all moving parts to stop before servicing, adjusting, repairing.
- Relieve pressure from hydraulic circuit before servicing.
- Before applying pressure to a hydraulic system, ensure all components are tight and that hoses and couplings are in good condition.
- Keep hands, feet, hair, and clothing away from all moving/rotating parts.
- Replace parts with genuine factory replacements parts to restore your equipment to original specifications.



Meridian Manufacturing Inc. will not be responsible for injuries or damages caused by using unapproved parts and/or accessories.

- Make sure there is plenty of ventilation. Never operate the engine in a closed building. The exhaust fumes may cause asphyxiation.
- Clear the area of bystanders, especially children, when carrying out any maintenance and repairs or making any adjustments.
- Place stands or blocks under the frame before working beneath the machine.
- Before resuming work, install and secure all guards when maintenance work is completed.
- Replace damaged or not clearly visible decals.

2.10 TIRE SAFETY

- Failure to follow procedure when mounting a tire on a wheel or rim can produce an explosion and may result in serious injury or death.
- Do not attempt to mount a tire unless you have proper equipment and training to do the job.
- Have a qualified tire dealer or repair service perform required tire maintenance.
- When replacing worn tires, make sure they meet original tire specifications. Never undersize.
- Reference the tire side wall for information on the maximum cold tire pressure (PSI). Keep the tires inflated to this setting.





2.11 BATTERY SAFETY

- Keep all sparks and flames away from battery, as the gas given off by electrolyte is explosive.
- Avoid contact with battery electrolyte. Wash off any spilled electrolyte immediately.
- Wear safety glasses when working near batteries.
- Do not tip batteries more than 45 degrees, to avoid electrolyte loss.
- To avoid injury from spark or short circuit, disconnect battery ground cable before servicing any part of electrical system.
- When storing conveyor for an extended period:
 - Remove the battery.
 - Be sure it is fully charged.
 - Store it inside.
 - Do not sit battery on a cold, concrete floor.
- Before using the battery, after it has been in storage, be sure it is charged.



2.12 ENGINE SAFETY

- Read and understand the operating manual provided with the engine. 
- Use proper tools to service engine.
- Do not run engine in an enclosed area. Exhaust gases contain carbon monoxide, an odorless and deadly poison.
- Store fuel in approved safety containers.
- Do not store fuel near open flame. 

Appliances such as a stove, furnace, or water heater use a pilot light which can create a spark. 
- No smoking when filling fuel tank.
- Do not remove fuel cap while engine is running.
- Do not refuel indoors where area is not well ventilated. Outdoor refueling is preferred.
- Do not refuel while engine is running. Allow engine to cool for 5 minutes before proceeding.
- Use fresh fuel. Stale fuel can gum carburetor and cause leakage.
- Check fuel lines and fittings frequently for cracks or leaks. Replace if necessary.
- Do not operate engine if fuel has spilled. Move machine away. Avoid creating any ignition until the fuel has evaporated.
- Do not run engine above rated speeds. This may result in damage and injury.
- Do not tamper with the engine speed selected by the original equipment manufacturer.
- Do not operate engine with grass, leaves, dirt or other combustible materials in muffler area.
- Do not operate engine without muffler.

- Do not tamper with governor springs, governor links or other parts which may increase the governed engine speed.
- Do not strike flywheel with hard object or metal tool. This may cause it to shatter in operation.
- Keep cylinder fins/governor parts free of grass and other debris which can affect engine speed.

WARNING

HOT EQUIPMENT HAZARD

Do not touch muffler, cylinder or fins while engine is running. Contact will cause burns.

- Do not use this engine on any forest covered, brush covered, or grass covered unimproved land, unless a spark arrester is installed on muffler. The arrester must be maintained in effective working order by operator.

In the State of California the above is required by law (Section 4442 of the California Public Resources Code). Other states may have similar laws. Federal laws apply on federal lands.

- Inspect the muffler periodically. Replace it when necessary.

If engine is equipped with a muffler deflector, inspect periodically. Replace with correct part.

- Do not check for spark, or crank engine with spark plug or spark plug wire removed.
- Do not run engine with air filter or its cover removed.

NOTICE

Possible Engine Damage

Decelerate engine slowly to stop. Avoid choking the carburetor to stop engine. Choke only for an emergency stop.

2.13 OPERATING SAFETY

- Anyone who will be operating this conveyor, or working around it, must read this manual. They must know operating, maintenance, safety info.



Review the manual annually.

- Clean or replace all safety decals if they cannot be clearly read and understood.
- Place all controls in neutral, and stop the engine. Remove the ignition key. Wait for all moving parts to stop before adjusting, repairing or unplugging.
- Keep all bystanders, especially children, away from the machine when running.

Also, when authorized personnel are carrying out maintenance work.

- Establish a Lock-Out, Tag-Out policy for the work site. Be sure all personnel are trained in and follow all procedures.

Lock-out, tag-out all power sources before servicing the unit or working around equipment.

- Be familiar with machine hazard area. If anyone enters hazard areas, shut down machine immediately. Clear the area before restarting.

- Keep hands, feet, hair and clothing away from all moving/rotating parts.



- Do not allow riders on the conveyor when moving or transporting it.

- Keep working area clean and free of debris to prevent slipping/tripping.



- Stay away from overhead obstructions and power lines during operation and transporting. Electrocutation can occur without direct contact.

- Do not operate the conveyor when any guards are removed.

- Chock wheels of conveyor before starting.
- Be sure that conveyor tube is empty before raising or lowering.
- Close hydraulic lift ball valve when machine is in working position or before transporting.
- High winds may overturn conveyor. To avoid damage to structures and equipment, do not raise conveyor fully in windy conditions.

Do not leave conveyor raised, when not in use.

2.14 HYDRAULIC SAFETY

- Always place hydraulic controls in neutral. Then relieve pressure in hydraulic system before maintaining or working on machine.
- Be sure that all components in the hydraulic system are kept in good condition and are clean.
- Replace any worn, cut, abraded, flattened or crimped hoses.
- Do not attempt any makeshift repairs to the hydraulic fittings or hoses by using tape, clamps or cements. The hydraulic system operates under extremely high-pressure. Such repairs will fail suddenly and create a hazardous and unsafe condition.

- Wear proper hand and eye protection when searching for a high-pressure hydraulic leak. Use a piece of wood or cardboard as backstop instead of hand to isolate/identify a leak.



- If injured by a concentrated high-pressure stream of hydraulic fluid, seek medical attention immediately. Serious infection or toxic reaction can develop from hydraulic fluid piercing the skin surface.



2.15 WORKPLACE HAZARD AREA

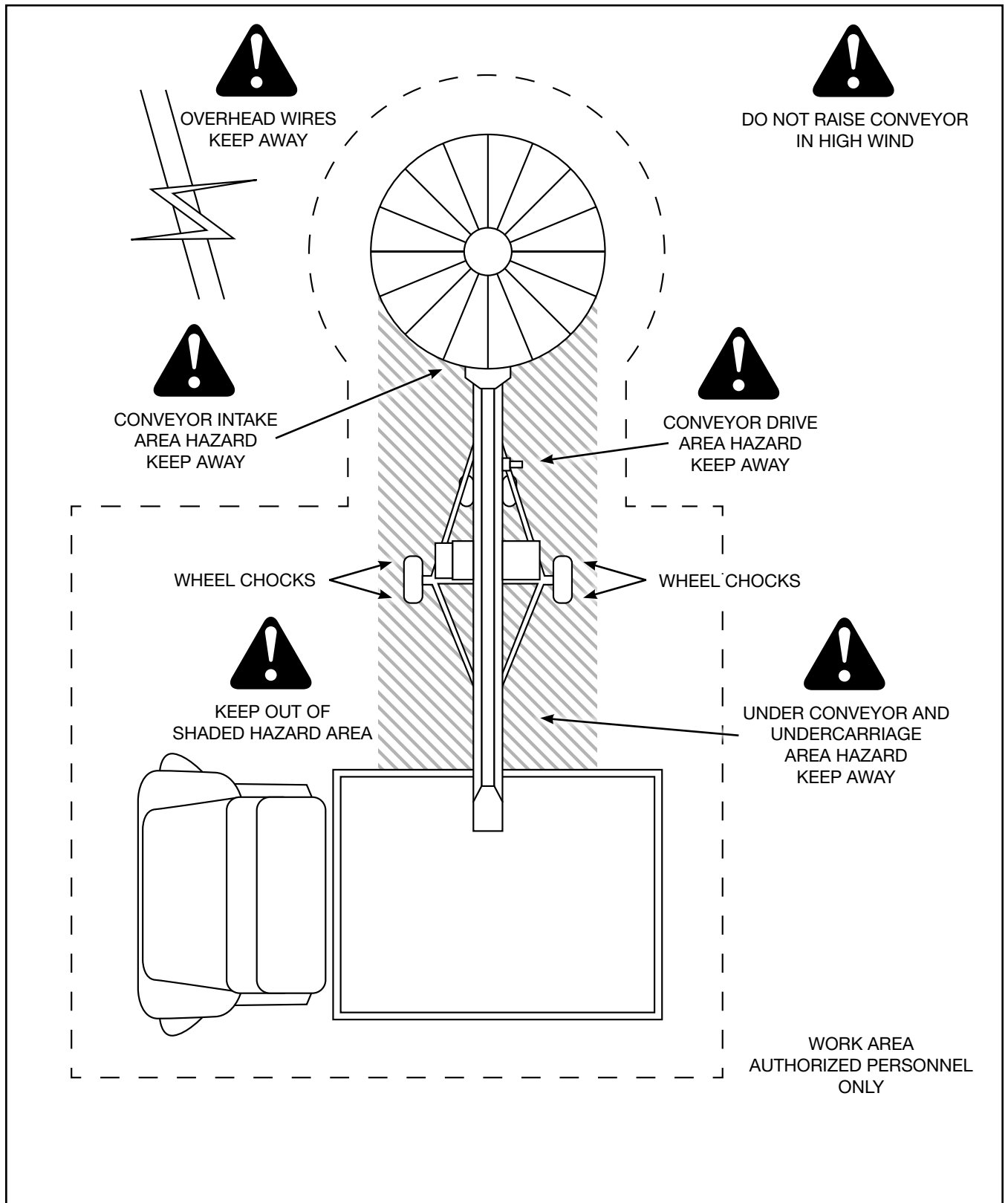

Fig 3 - Workplace Hazard Area

2.16 TRANSPORT SAFETY

- The conveyor belt must be empty before raising or lowering the tube.
- Always transport conveyor in collapsed position.
- Ensure all lights, reflectors, other lighting requirements are installed and in good condition.
- Never allow riders on the conveyor.
- Comply with all local laws governing safety and transporting of equipment on public roads.
- Do not exceed a safe travel speed. Slow down for rough terrain and when cornering.
- Stay away from overhead power lines. Electrocutation can occur without direct contact.
- Plan your route to avoid heavy traffic.
- Do not drink and drive.
- Be a safe and courteous driver. Always yield to oncoming traffic in all situations, including narrow bridges, intersections, etc. Watch for traffic when driving near or crossing roadways.

2.17 STORAGE SAFETY

- Store the conveyor on a firm, level surface.
- Store in an area away from human activity.
- If required, make sure the unit is solidly blocked up.
- Remove the battery and store in dry location. Do not sit battery on a cold, concrete floor.
- Make certain all mechanical locks are safely and positively connected before storing.
- Do not permit children to play on or around the stored machinery.

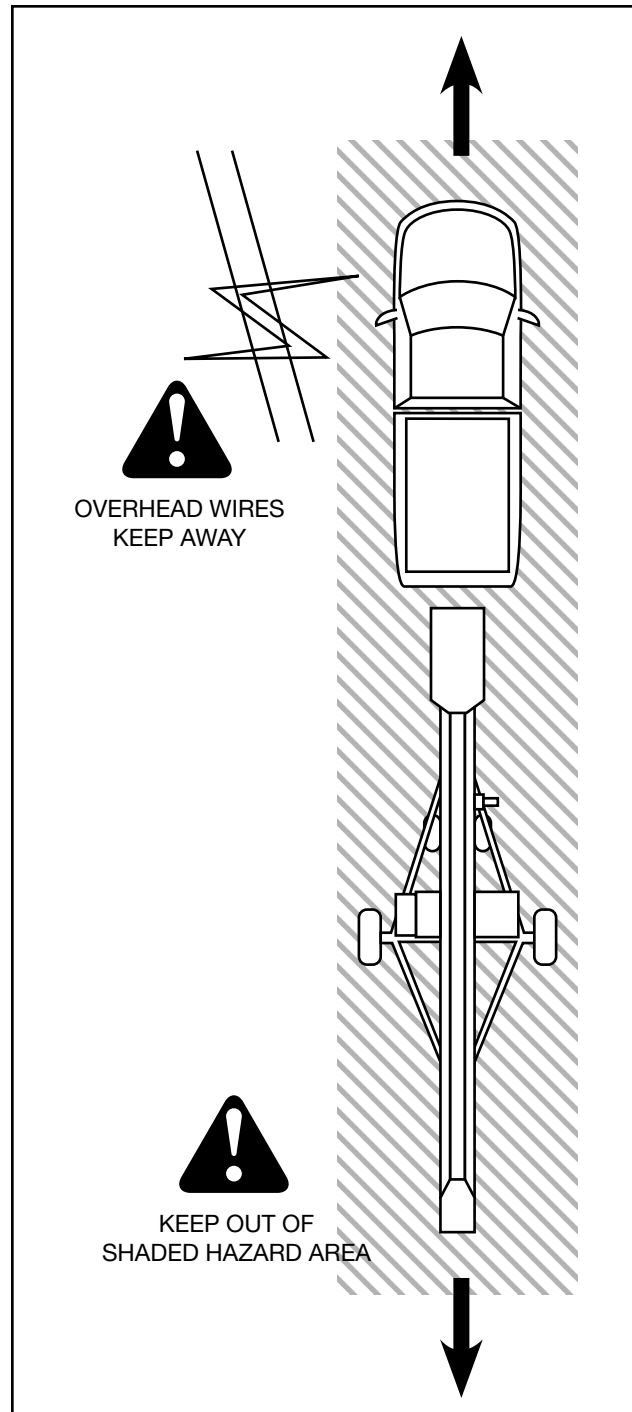

Fig 4 - Transporting Hazard Area

Section 3: OPERATION

WARNING

- Read and understand the Operator's Manual, and all safety decals, before using.
- Stop the engine. Place all controls in neutral, remove ignition key and wait for all moving parts to stop before servicing, adjusting, or repairing or unplugging.
- Clear the area of bystanders, especially children, before starting.
- Keep working area clean and free of debris to prevent slipping or tripping.
- Keep hands, feet, hair and clothing away from all moving and/or rotating parts.
- Do not allow riders on the conveyor when driving mover kit.
- Stay away from overhead obstructions and power lines during operation. Electrocution can occur without direct contact.
- Do not operate conveyor with guards removed.
- Chock wheels of conveyor before starting.
- Be familiar with machine hazard area. If anyone enters hazard areas, shut down machine immediately. Clear area before restarting.
- Establish a lock-out, tag-out policy for the work site. Be sure all personnel are trained in and follow all procedures. Lock-out tag-out all power sources before servicing the unit.

The Convey-All™ Truck Load conveyor is designed to efficiently move grain, pulse crops, or granular material between a storage facility and a truck and trailer. Power is provided by a gas or diesel engine. Be familiar with the conveyor and engine before starting.

It is the responsibility of the owner and operators to read this manual and to train all personnel before they start working with the machine. Follow all safety instructions exactly - it is everyone's business. By following recommended procedure, a safe working environment is provided for the operator, co-workers and bystanders in the area around the work site.

The design and configuration of this conveyor includes safety decals and equipment. Hazard controls and accident prevention are dependent upon the personnel operating and maintaining it. Their awareness, concern, prudence and proper training are crucial.

Many features incorporated into this machine are the result of suggestions made by customers like you.

By following the operating instructions, in conjunction with a good maintenance program, your Truck Load conveyor will provide many years of trouble free service.

3.1 MACHINE COMPONENTS

This conveyor is available in three lengths.

A gas or diesel engine supplies power to run the hydraulics, making this conveyor a self-contained, self-propelled unit.

A hydraulic cylinder is used to lower the steering wheels when driving the unit. Another cylinder raises and lowers the tube.

Components may vary, and their positions may change depending on the options contained on the conveyor.

The main components are listed below:

- a. Main Tube
- b. Hopper
- c. Discharge Spout
- d. Discharge Spout Electric Actuator
- e. Undercarriage
- f. Hopper Winch
- g. Conveyor Belt Wind Guard
- h. Drive Box with Tension Springs
- i. Engine, Electrical and Hydraulic Controls
- j. Hydraulic Reservoir and Fuel Tank
- k. Drive Wheels
- l. Steering Wheels
- m. Working Lights
- n. Hitch
- o. Jack
- p. Document Holder

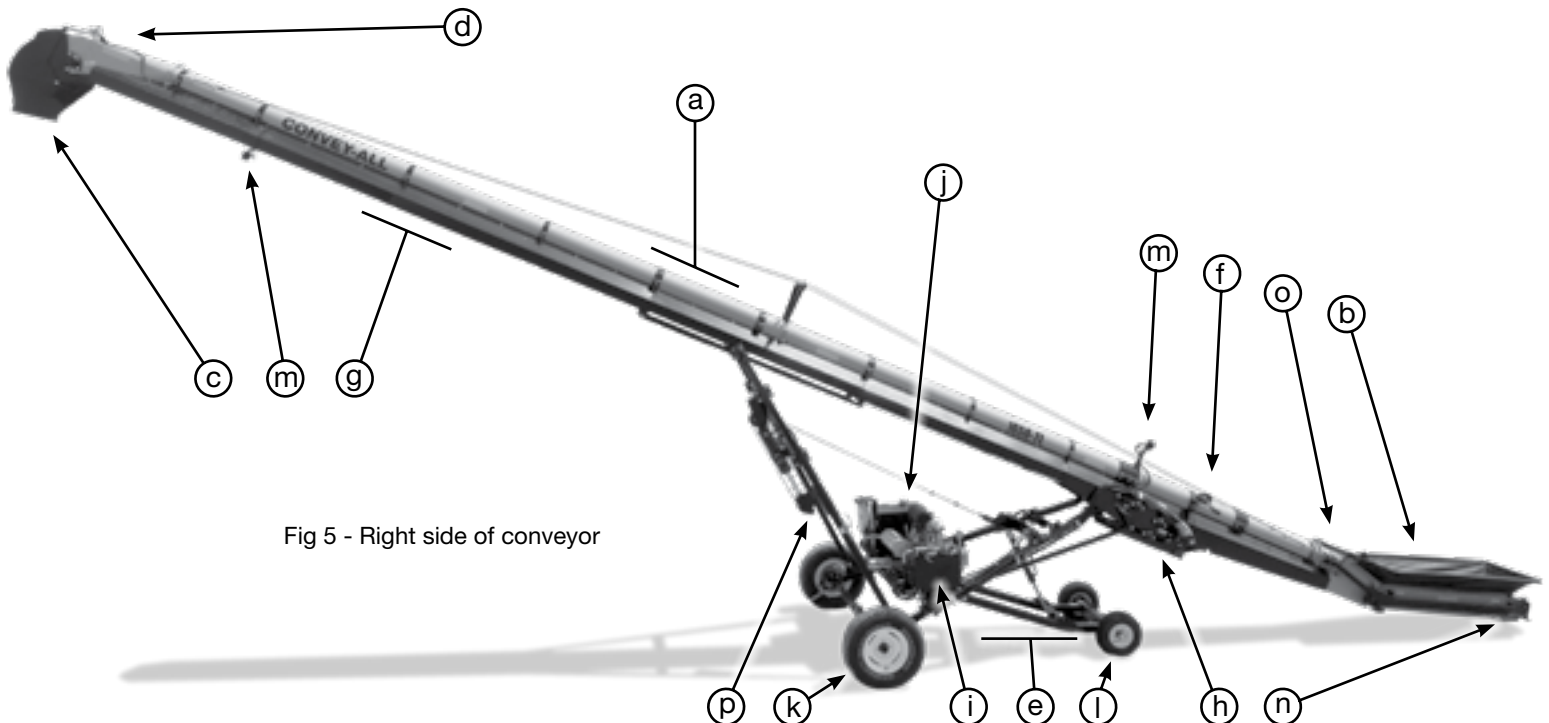

Fig 5 - Right side of conveyor

3.2 COMPONENTS AND CONTROLS

Before starting to work, all operators must familiarize themselves with the location and function of the components and controls of their specific unit.

Options and locations may change without notice.

Refer to the engine manufacturer's manual for more detailed information.

Engine controls may vary depending on model.

Gas Engine:

- a. Ignition Switch:
Insert the key to operate.
- b. Choke:
Choke valve for starting when the engine is cold. Slide to the left to open the choke as the engine warms.
- c. Throttle:
This lever controls the engine RPM.

Always open choke fully when operating conveyor.

IMPORTANT:

Always run at maximum engine speed, which is 3600 RPM, when operating the conveyor belt.

Cold Weather Pkg for Gas Engine (Optional):

Features a muffler shroud ducted into the air intake of the engine feeding warm air to keep the carburetor from icing up.

125 Watt Heater for Engine (Optional):

This heater is attached to the bottom of the engine, and contains an electrical cord.



Fig 6 - Gas engine



Fig 7 - Engine controls



Fig 8 - Cold weather package



Fig 9 - 125 watt heater for engine

Diesel Engine (Optional):

The diesel engine offered as an option has the tier 4 rating. Refer to the engine manufacturer's manual for detailed information.

Engine and controls may change without notice.

- a. Ignition Switch:
The key'd ignition switch is on the control box along with the system display.
- b. Throttle:
The red dial, between the hydraulic valve levers, control the engine RPM. Rotate to increase or decrease the engine speed.

IMPORTANT:

Always run at maximum engine speed, which is 3600 RPM, when operating the conveyor belt.

Fuel Tank:

The tank has a capacity of 57 Litres (15 US Gallons).

Hydraulic Oil Reservoir:

The reservoir holds 95 Litres (25 US Gallons).

Block Heater (Optional):

An electric heater patch, can be glued to the bottom of the engine block.

Oil Tank Heater (Optional):

An electric heater patch, can be attached to the bottom of the Hydraulic Reservoir.

Oil Cooler (Optional):

A fan can be mounted in front of the hydraulic reservoir.



Fig 10 - Tier 4 diesel engine

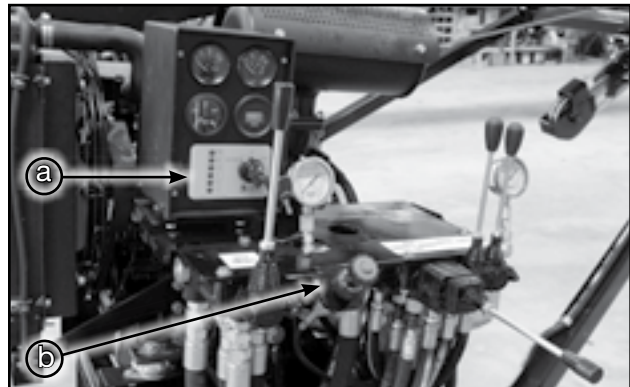

Fig 11 - Engine controls

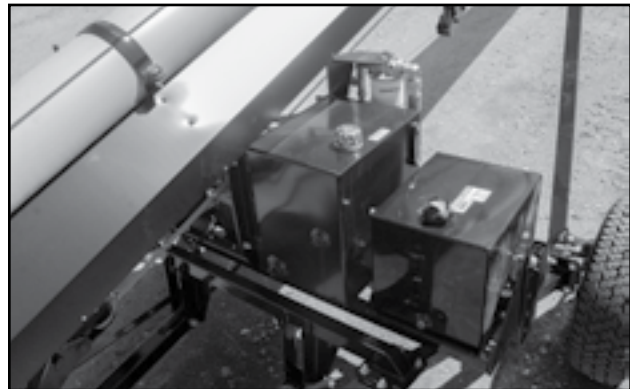

Fig 12 - Fuel tank and hydraulic reservoir



Fig 13 - Oil cooler

Hydraulic Controls:

The hydraulic valve bank is beside the engine. There are two gauges on the valve bank, one to monitor the moving/lifting circuit, and one for the conveyor belt circuit.

- a. Mover Kit Lever:
This 4 position, spring-loaded lever controls the movement of the conveyor. It drives the wheels forward and reverse, and also swivels the steering wheels for turning left or right.

- b. Conveyor Lift:
This lever raises and lowers the conveyor tube.

Note:

A ball valve is located on the lift arm.
Open, to raise or lower conveyor.
Close, to lock in position. See Figure 16

- c. Hopper Lift:
This lever controls the height of the steering wheels, which in turn moves the hopper.
- Lower the wheels, to raise the hopper when driving the unit.
- Raise the wheels, lowering the hopper into position for unloading.
- d. Conveyor Belt Control:
The hydraulic motor controlling the conveyor belt is turned on and off with this lever.

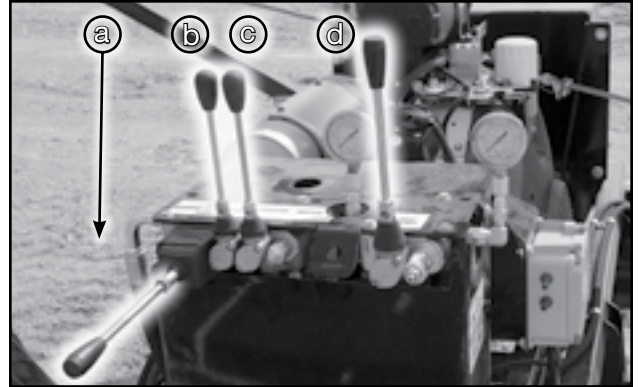

Fig 14 - Valve bank

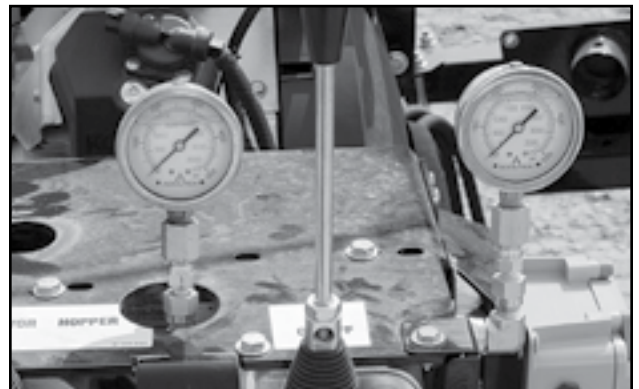

Fig 15 - Hydraulic pressure gauges

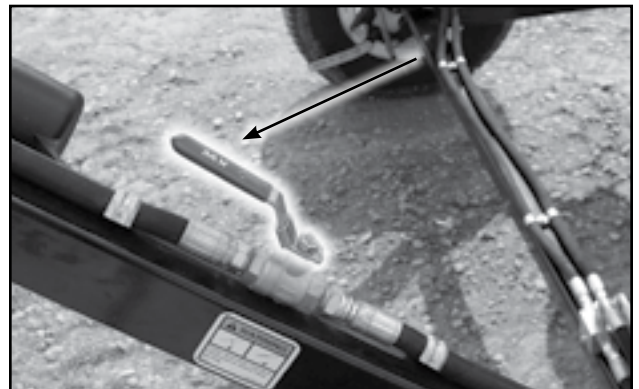

Fig 16 - Hydraulic valve to the lift cylinder

Ball Valve to Conveyor Tube Lift Cylinder:

This valve allows oil into or out of the hydraulic cylinder that raises/lowers the tube.

IMPORTANT:

Hydraulic valve must be fully opened prior to raising/lowering conveyor.

Always close valve fully when conveyor is to remain in fixed position. This will prevent the ram from creeping downward during operation.

NOTICE**EQUIPMENT DAMAGE LIKELY**

Always disengage both drive wheels before towing. Hydraulic motors will be damage if driven at highway speeds.

Drive Wheels:

The driven wheels have a lever to manually engage or disengage the hydraulic drive mechanism. When disengaged, insert the retaining clip to secure.

NOTICE**UPENDING HAZARD**

Raise the steering wheels with caution.
The conveyor may become unstable and upend.

Steering Wheels:

A hydraulic cylinder raises and lowers the wheels. A check valve locks the wheels, when they are raised.

Use the mover kit lever on the hydraulic valve bank to turn the wheels when driving the conveyor.

Drive Box and Hydraulic Motor:

This conveyor uses a Spring Tension Drive Box. The 10" drive roller and 5" pinch roller ensures more belt-to-drive roller contact. Spring tension and constant pressure results in less adjusting required.



Fig 17 - Disengaged drive wheel



Fig 19 - Steering wheels



Fig 18 - Drive box

Chevron Belt with Alligator® Lacing:

Convey-All™ conveyors use a 2 ply, 220 weight, chevron belt with Alligator® Lacing.

⚠ WARNING

MOVING BELT HAZARD

Never climb into hopper onto the belt.
The belt may inadvertently be turned on.

Hopper:

The hopper is designed with spring loaded canvas frame. This allows the truck box to push the frame down.

The hoppers has rubber flashing to seal the junction between the belt and the sides of the hopper.

The hopper is also available in stainless steel.

⚠ WARNING

UNEXPECTED MOVEMENT HAZARD

Do not release hopper winch handle when ratchet lever is unlocked with load on winch. The handle could spin violently causing serious injury.

Hopper Winch:

The winch is located on the side of the tube just above the hopper. It is used to lower the canvas frame.

Rail Car Hopper (Optional):

This hopper has a very low profile to allow for positioning under a rail car hopper.

A winch is used to raise and lower hopper sides.

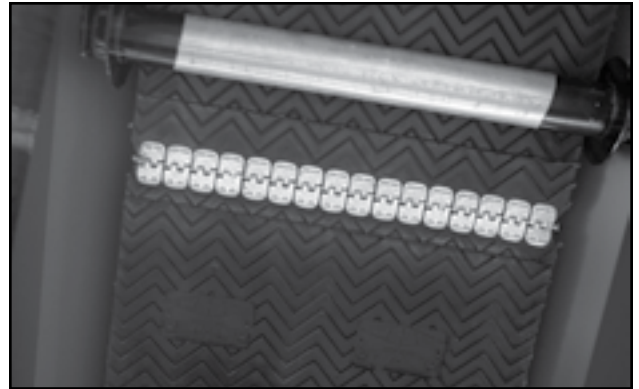

Fig 20 - Chevron belt with Alligator® lacing



Fig 21 - Hopper

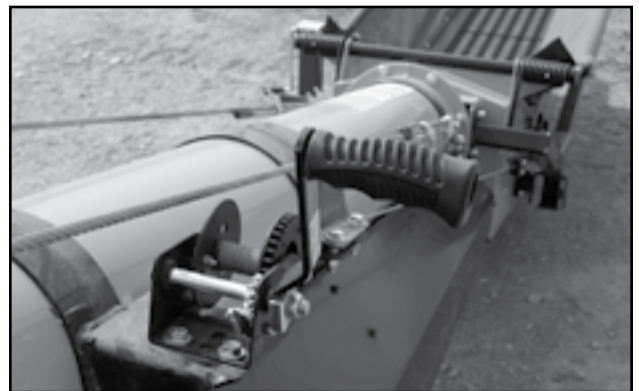

Fig 22 - Hopper winch

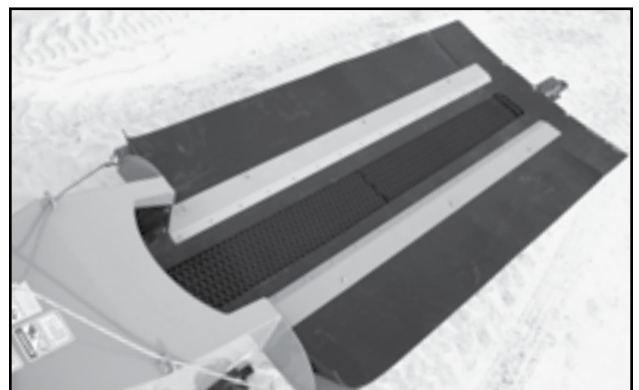

Fig 23 - Rail car hopper

Discharge Spout:

The discharge spout comes with bolt holes along the top. It can be manually tilted and bolted into place, so product can be further out rather than straight down.

Remove the spout to throw the material as far as possible. This configuration works well when making piles or working inside buildings.

The discharge is also available in stainless steel.

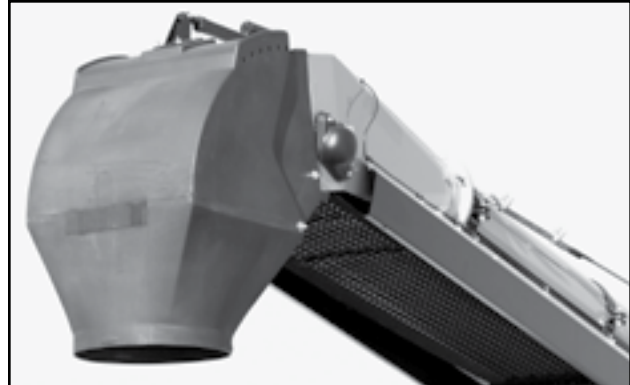

Fig 24 - Discharge spout

Electric Actuator on Discharge Spout:

The discharge spout comes with a 12 volt DC electric actuator. This repositions the spout, tilting it for precise control over product output.

It is controlled by a switch on the junction box next to the hydraulic valves.



Fig 25 - Electric actuator

Working Lights:

Working lights are installed to illuminate the hopper and discharge ends of the machine. The 12 volt DC working lights make operating the conveyor at any time safe and convenient.

The light switch is on the side of the valve bank.



Fig 26 - Working light

Transport Light Package (Optional):

On certain models, a 12 volt DC transport light package is available. The wiring harness would plug into a truck.

Quad-Swivel Discharge Spout (Optional):

This is an extension to the standard spout, which hangs down from it. An electric actuator is attached to the extension to swing it sideways.



Fig 27 - Quad-swivel discharge spout and transport lights

Electric Switches:

On the side of the valve bank, is a junction box with switches. They work the lights, and the discharge actuator.



Fig 28 - Electric switches

Angle of Operation Indicator:

On the side of the drive box, is a decal to assist in calculation of the operating angle.

Hold the end of a weighted string against the red arrow (above the Convey-All™ logo). Reference the graph and read at what angle the string lies.



3618000004

Fig 30 - Angle of Operation decal

Hitch and Jack Storage Plate (Optional):

There is a plate mounted onto the conveyor's undercarriage. This is where the Hitch and Jack may be stored, when not in use.



Fig 29 - Storage plate

2-5/16 Inch Ball Receiver:

A ball receiver is available to replace the standard hitch.

Wheel Chocks:

Wheel Chocks are available.

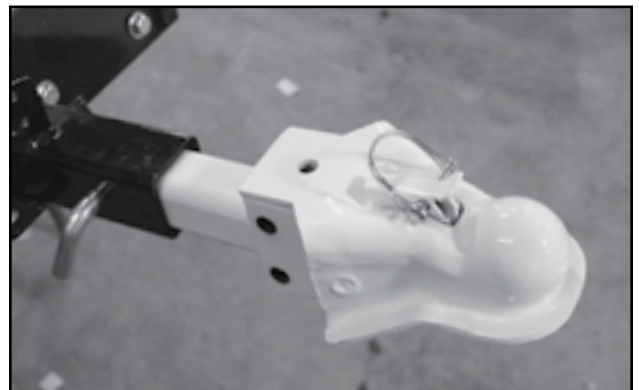

Fig 31 - 2-5/16 ball receiver

3.3 MACHINE BREAK-IN

There is no operational restrictions on the conveyor when used for the first time.

The conveyor belt alignment is set at the factory, to track correctly without carrying a load.

Before Starting Work:

1. Read conveyor and engine operator manuals.
2. Run the unit for half an hour to seat the conveyor belt and hopper flashing. It is normal for rubber from the flashing to be expelled out the discharge and form a pattern on the belt.

After Operating or Transporting for 1/2 hour:

3. Re-torque all the wheel bolts.
4. Check fuel, engine oil and hydraulic oil levels.
5. During the conveyors first few minutes of operation, check belt tension and alignment to ensure the factory preset does not vary under loaded conditions.
6. Check the flashing seal on the hopper. If any product comes out of the hopper around the flashing; stop the belt, loosen flashing mounting screws and adjust. Retighten anchor screws and try again. Repeat until no product is lost.
7. Check the condition of all hydraulic lines, hoses and connections. Repair or replace any damaged system components.
8. Check that all guards are installed and function as intended.

After Operating For 5 Hours and 10 Hours:

Repeat steps 1 through 8 above.

Service and maintain the conveyor as defined in Section 4: Service and Maintenance.

3.4 PRE-OPERATION CHECKLIST

Efficient and safe operation of the conveyor requires that each operator knows the operating procedures.

It is important for both the personal safety and maintaining the good mechanical condition of the machine that this checklist is followed.

Before operating the conveyor, and each time thereafter, the following areas should be checked.

1. Check worksite. Clean up working area to prevent slipping or tripping.
2. Be sure that the battery is fully charged. If needed, charge the battery before connecting it with the battery cables.
3. Lubricate and service the machine as per the schedule outlined in the Section 4.2.
4. Check that all guards are installed, secured and functioning as intended. Do not operate with missing or damaged shields.
5. Check that the belt is properly tensioned and aligned. Ensure it is not frayed or damaged. Refer to Section 4.3.1 and 4.3.2
6. Be sure conveyor wheels are chocked.
7. Check that discharge and intake hopper areas are free of obstructions.

NOTICE

UPENDING HAZARD

Anchor or support conveyor during operation. When lower half empties of material, the weight balance transfers to the discharge end of the machine, which can cause upending.

3.5 ATTACHING TO TOW VEHICLE

⚠ DANGER

ELECTROCUTION HAZARD

Ensure enough clearance from overhead obstructions, power lines or other equipment.

1. Clear the working area of bystanders, especially small children.
2. If the conveyor is in a working position:
 - Use the mover kit, to drive conveyor away from the bin and out of the work area.
 - Lower the tube to it's collapsed position.
3. Ensure that there is sufficient room and clearance to back up to the conveyor.

NOTICE

UPENDING HAZARD

The machine is closely balanced. Do not lift unless there is downward weight on the hopper end to prevent upending.

4. Use the mover kit to raise hopper.
5. Install the hitch with the anchor pin. Place the retainer before using hitch.
6. Align the tow vehicle's drawbar with the hitch of the conveyor while backing up.
7. Set park brake before dismounting tow vehicle.
8. Install the pin with its retainer clip, to connect the tow vehicle.
 - Secure the safety chain.
9. Raise the steering wheels.
10. Remove and store the jack.
11. Close hydraulic valves and turn off engine.



Fig 32 - Jack



Fig 33 - Hitch



Fig 34 - Attached to tow vehicle

3.6 CONVEYOR PLACEMENT

Follow this procedure when placing the conveyor into its working position:

1. Clear the area of bystanders, especially small children, before starting.
2. Transport the conveyor to the working area. Refer to Section 3.9
3. Start the conveyor's engine.
4. Lower the steering wheels.
5. Detach the conveyor from the tow vehicle.

⚠ CAUTION

SAFETY HAZARD

Remove hitch from conveyor to prevent interference and clear a tripping hazard.

6. Remove and store the hitch.

⚠ DANGER

ELECTROCUTION HAZARD

Ensure enough clearance from overhead obstructions, power lines or other equipment.

7. Remove the retainer clips, and manually engage the drive wheels on the conveyor's mover kit.
8. Drive the conveyor into working position while the tube is lowered.

NOTICE

HIGH WIND HAZARD

Do not operate or leave conveyor fully raised, in high winds. It may blow over, damaging structures and equipment.



Fig 35 - Start engine



Fig 36 - Place under bin

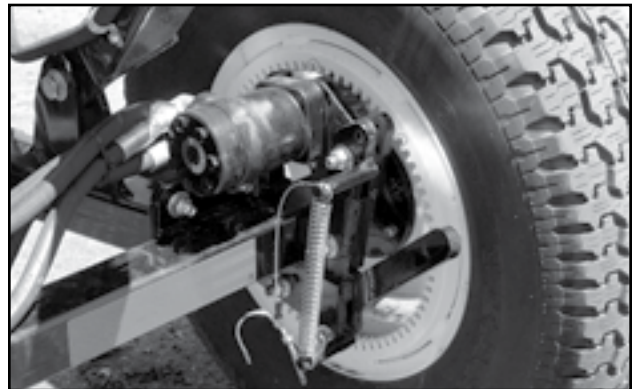

Fig 37 - Engage drive wheel



Fig 38 - Hitch and jack storage

⚠ WARNING**PINCH POINT HAZARD**

As the A-frame undercarriage is raised and lowered, pinching can occur.
Keep away from moving parts.

9. Carefully position the hopper under the bin.
10. Use the hydraulics to raise the conveyor tube to working height.

IMPORTANT:

To prevent damage to the conveyor tube and belt, be sure it does not rest on any structure.

11. Raise the steering wheels, to lower the hopper to the ground.

NOTICE**UPENDING HAZARD**

Always check the weight of the hopper end to prevent upending.

12. Stake or weigh down the hopper end to prevent upending when the machine is emptying.
13. Close the ball valve to lock the tube in the raise position.
14. Chock drive wheels to prevent movement.

Note:

Chocks are not included with conveyor.

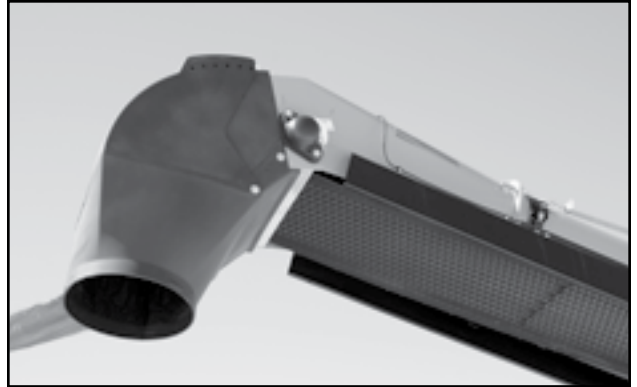

Fig 39 - Discharge spout



Fig 40 - Hydraulic valve to lift cylinder



Fig 41 - Chocked drive wheels

3.7 OPERATING ON SITE

When operating conveyor, follow this procedure:

1. Clear the area of bystanders, especially small children, before starting.
2. Review the Pre-Operation Checklist before starting. Refer to Section 3.4
3. Review the Workplace Hazards illustration and use extra care when inside the hazard area. Keep all spectators and bystanders out of this area.

Should anyone enter the hazard area, stop the machine immediately.

4. Check that all guards are in place and working as intended.
5. Once the conveyor is in position under a bin, move the truck/tender into position for loading.

NOTICE

HIGH WIND HAZARD

Do not operate or leave conveyor, fully raised, in high winds. Avoid damage to structures and equipment, by always lowering conveyor.

3.7.1 Starting Conveyor:

6. Move throttle to the idle position.
 - Close the choke if the engine is cold.
7. Start the engine.
8. Run for 2-3 minutes to allow engine to warm.
9. Increase engine speed to full throttle.
10. Start to rotate the conveyor belt by using the hydraulic valve lever.
11. Open the bin gate, to start the flow of product and unload into the conveyor hopper.

3.7.2 Stopping Conveyor:

12. Stop unloading, and wait for conveyor belt to empty completely.
13. Stop the conveyor belt.
14. Move the throttle to idle position.
15. Turn off the engine and remove ignition key.

3.7.3 Emergency Stopping:

Although it is recommended that the tube be emptied before stopping, in an emergency situation, stop the engine immediately.

See to the emergency. Correct the situation before resuming work.

3.7.4 Restarting after Emergency Stop:

When the conveyor is shut down inadvertently or in an emergency, the conveyor belt will still be covered with product.

Remove as much product from the hopper as possible, before restating the engine.

Since start-up torque loads are much higher than normal when belt is full, restart at a low engine speed. The engine speed can be increased to full throttle, when the belt is empty.

Now, product can again be unloaded into the conveyor hopper.

3.7.5 Unplugging:

In unusual moisture, crop or product conditions, the machine can become plugged. When unplugging, follow this procedure:

1. Stop the conveyor belt.
2. Turn off the engine.
3. Lock-out, tag-out the controls.
4. Remove product from the discharge and hopper area.
5. Reposition the conveyor if discharge area plugs due to lack of clearance.
6. Restart using the same procedure as if after an emergency stop. Refer to Section 3.7.4

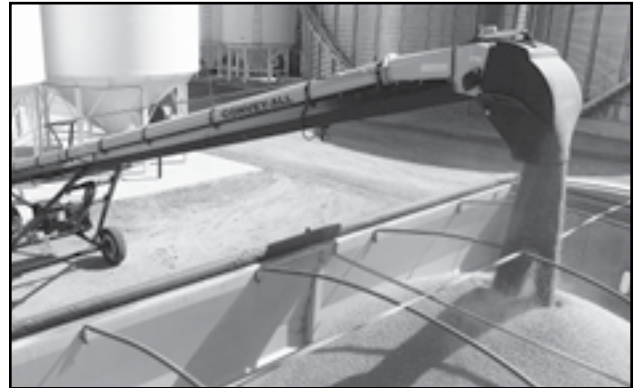

Fig 42 - Filling truck on site

3.8 OPERATING HINTS

- Keep the hopper full for maximum capacity. Most efficient results will be obtained when flow of incoming product is directed at the top of the hopper (closer to the tube).
- Always listen for any unusual sounds or noises. If any are heard, stop the machine and determine the source. Correct the problem before resuming work.
- Do not run the machine for long periods of time with no product on the belting. This will increase the wear. Try to run only when moving product.
- Do not support discharge end directly on the truck or trailer.
- Stake the hopper or weigh it down to prevent upending.
- The hopper is designed with flashing to seal the junction of the belt with the sides of the hopper. It must be kept in good condition to prevent the material from “leaking” out of the hopper. Replace flashing if “leakage” occurs.
- Belt Speed:
The best results are obtained when the engine is set to provide a belt speed of 600 ft./min.

Count the number of belt revolutions per unit time to determine belt speed. Use the belt lacing as a reference when counting belt revolutions.

Contact your dealer or the factory for the appropriate drive components to give the recommended belt speed.

- Belt Tension:
There may be a rapid decrease in belt tension during the first few hours of operation until the belt has worn in.

The correct operating tension is the lowest tension at which the belt will not slip under peak load conditions.

- Operating Angle:
The hydraulic lift can set the tube angle at any position between 12° and 30° when operating. Because the belt does not have roll-back barriers, the product will roll-back if the angle is too steep. Do not position at more than 30°.

Note:

The lower the angle,
the greater the capacity.



Fig 43 - Full hopper

3.9 TRANSPORTATION

Convey-All™ Truck Load conveyors are designed to be easily and conveniently moved from place to place.

When transporting the conveyor, follow this procedure:

1. Refer to Section 3.5 to attach conveyor to tow vehicle.

NOTICE

EQUIPMENT DAMAGE LIKELY

Always disengage drive wheels before transport. Hydraulic motors will be damaged if driven at highway speeds.

2. Ensure the conveyor is ready for transport:
 - It is in its fully collapsed position.
 - Drive wheels are disengaged, and retainer clip is fastened in place.
 - Hydraulic lines are closed.
 - Hitch is attached using anchor pin, retainer and safety chain.
3. Be sure all bystanders are clear of the machine.
4. Conveyor is hitched to the tow vehicle and safety chains are secured.
5. Jack is raised, removed and stored.
6. Remove chocks from around conveyor wheels.
7. If equipped with transport lights, connect the wiring harness across the hitch.
 - Secure with clips, zip ties or tape. Provide slack for turning.

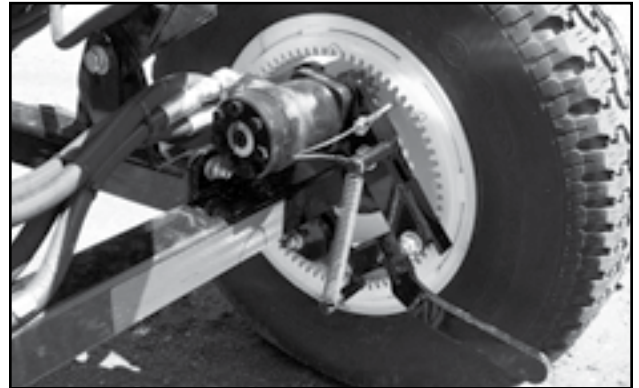

Fig 44 - Disengage drive wheels



Fig 45 - Hitch attached to tow vehicle

8. Ensure the SMV (Slow Moving Vehicle) emblem, all lights and reflectors required by local highway and transport authorities are in place.

They must be clean and clearly visible by all overtaking and oncoming traffic.

9. Do not allow riders on the conveyor.
10. Slowly pull away from the working area.
 - Be sure everything is connected and nothing is hanging.
11. Keep to the right and yield the right-of-way to allow faster traffic to pass. Drive on the road shoulder, if permitted by law.
12. Never travel across slopes of more than 20°. It is better to go straight up and down.
13. It is not recommended that the machine be transported faster than 80km/h (50mph).
14. During periods of limited visibility, use pilot vehicles or add extra lights to the machine.
15. Always use hazard flashers on the tow vehicle when transporting unless prohibited by law.



Fig 46 - Hitch and jack storage plate



Fig 47 - Remove chocks

3.10 STORAGE

After the season's use, or when the conveyor will not be used for an extended period of time, the conveyor should be thoroughly inspected and prepared for storage.

Repair or replace any worn or damaged components to prevent unnecessary down-time next season.

For a long, trouble-free life, this procedure should be followed when preparing the machine for storage:

1. Remove all left over product or residue from the hopper and inside tube.
2. Inspect all moving or rotating parts and remove anything which has become entangled.
3. Wash the entire machine thoroughly using a water hose or pressure washer to remove all dirt, mud, debris or residue.
 - Wash on top and under the belt.
 - Clean inside the tube.
4. Inspect all hydraulic hoses, fittings, lines, couplers and valves.
 - Tighten any loose fittings.
 - Replace any hose that is badly cut, nicked or abraded or is separating from the crimped end of the fitting.
5. Lubricate all grease fittings.
Refer to Section 4.2
 - Ensure all grease cavities have been filled with grease to remove any water residue from having been washing.
6. Check the condition of the conveyor belt.
Replace if necessary.
7. Remove the battery.
 - Be sure it is fully charged.
 - Store it inside.
 - Do not sit the battery on a cold, concrete floor.

8. Touch up all paint nicks and scratches to prevent rusting.
9. Select an area that is dry, level and free of debris.

If the machine cannot be placed inside, cover the engine with a waterproof tarpaulin and tie securely in place.

10. Do not allow children to play on or around the conveyor.

IMPORTANT:

If conveyor has been stored for over 6 months, run engine for 2-3 minutes. Then, change oil, while still warm, to remove any condensation.



Fig 48 - Collapsed position

This page intentionally left blank

Section 4: SERVICE AND MAINTENANCE

WARNING

- Review the Operator's Manual and all safety items before maintaining the conveyor.
- Clear the area of bystanders, especially children, before repairing or adjusting.
- Before servicing, repairing or unplugging; place controls in neutral, stop engine, remove ignition key and wait for moving parts to stop.
- Follow good shop practices:
 - Keep service area clean and dry.
 - Be sure electrical outlets and tools are properly grounded.
 - Use adequate light for the job at hand.
- Relieve pressure from the hydraulic circuit before servicing.
- Before applying pressure to a hydraulic system, make sure all components are tight, hoses and couplings are in good condition.
- Keep hands, feet, hair and clothing away from all moving and/or rotating parts.
- Make sure there is plenty of ventilation. Never operate the engine in a closed building. The exhaust fumes may cause asphyxiation.
- Place stands or blocks under frame before working beneath the unit.
- When maintenance is complete, before resuming work, install and secure all guards.
- Keep decals clean, replace if not readable.

By following the operating instructions, in conjunction with a good maintenance program, your conveyor will provide many years of trouble free service.

4.1 FLUIDS AND LUBRICANTS

Fuel and Engine Oil:

Refer to the engine's operator manual for specific information.

- Fuel tank capacity is 57 Litres (15 US Gal.)

Grease:

Use an SAE multipurpose high temperature grease with extreme pressure (EP) performance. Also acceptable, SAE multipurpose lithium based grease.

Hydraulic Oil:

Use an ISO grade 36 hydraulic oil for all operating conditions (Hydrex MV36 or comparable).

- Oil reservoir holds: 95 Litres (25 US Gal.)

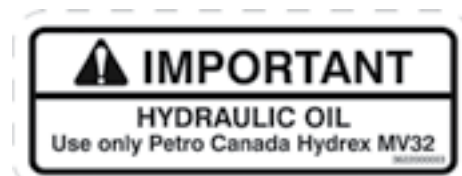

3622000003

Fig 49 - Hydraulic oil decal

Storing Lubricants:

Your machine can operate at top efficiency only if clean lubricants are used. Use clean containers to handle all lubricants.

Store them in an area protected from dust, moisture and other contaminants.

3.10.1 Greasing:**NOTICE****GREASING HAZARD**

Too much grease causes excessive overheating. Under-greasing accelerates equipment wear.

No grease should be seen around bearings. If there is, too much grease was applied and the seal has ruptured!

IMPORTANT:

Grease bearings only one pump per month under normal usage conditions.

Bearing greasing frequency should be determined by usage and conditions.

1. Use a hand-held grease gun for all greasing.
2. Wipe grease fitting with a clean cloth before greasing, to avoid injecting dirt and grit.
3. All bearings are greasable, but require only minimal grease.

Recommended greasing is one small stroke every month. Be careful not to over-grease as this may push the seal out.

4. Replace and repair broken fittings immediately.
5. If fittings will not take grease, remove and clean thoroughly. Also clean lubricant passageway. Replace fitting if necessary.

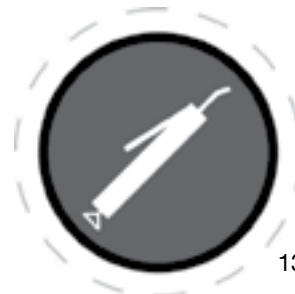

Fig 50 - Lubricate decal

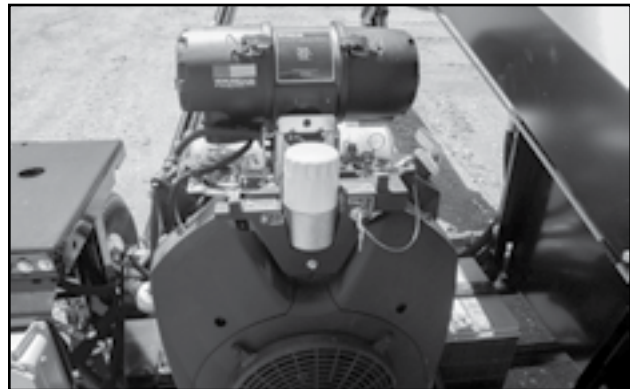

Fig 51 - Gas Engine

4.2 SERVICING INTERVALS

Use the Service Record provided on page 4-13, to keep a record of all scheduled maintenance.

The conveyor belt alignment is preset to run true under a condition of no load. It is important to check alignment and make adjustments, if required, during the initial few minutes of loaded operation.

Check bearings for wear daily.

The following recommended periods are based on normal operating conditions. Severe or unusual conditions may require more frequent lubrication and oil changes.

Schedules may vary depending on options and engine model contained in your equipment.

IMPORTANT:

For engine servicing and maintenance, refer to it's manual for complete details.

4.2.1 After 10 Hours or Daily:

1. Check fuel level.
 - Add as required.
2. Check oil level in hydraulic reservoir.
 - Add as required.
3. Inspect conveyor belt lacing for wear.
4. Check the conveyor belt tension daily while breaking-in the conveyor.
 - Refer to Section 4.2.2
5. Check the conveyor belt alignment frequently during the first 10 hours of operation until it seats itself. Refer to Section 4.2.2
6. Inspect all rollers and bearings for play and wear.
 - Replace if necessary.

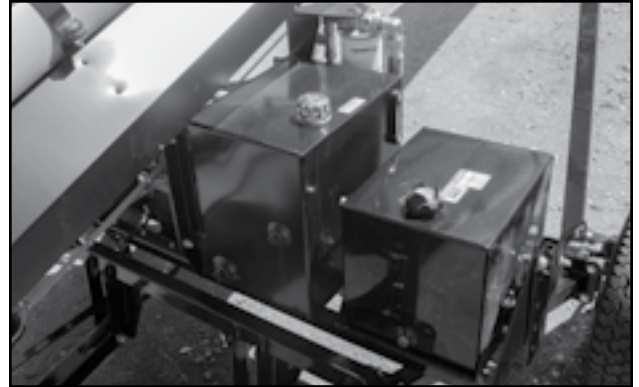

Fig 52 - Oil reservoir and fuel tank

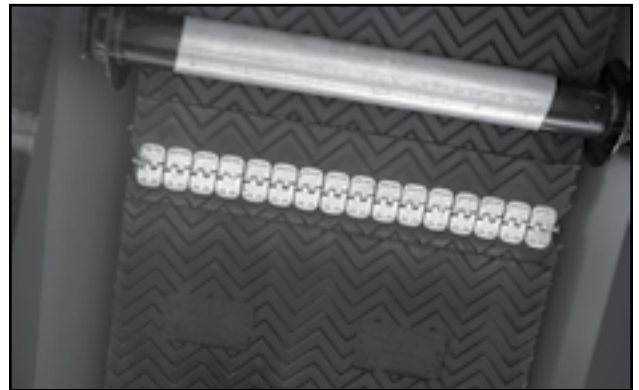

Fig 53 - Alligator® lacing



Fig 54 - Tail roller bearing

4.2.2 After 50 Hours or Weekly:

7. Check the conveyor belt tension.

Watch the tension more often while breaking-in the conveyor, because the belt may stretch. Refer to Section 4.3.1

Note:

A properly tensioned belt will not slip when in operation.

8. Check the conveyor belt alignment.
- How the belt is aligned to the rollers must be checked at the hopper, transition, at the drive box and the discharge.

Watch the alignment more frequently during the first 10 hours of operation. It usually seats itself and can be checked weekly after that. Refer to Section 4.3.2

9. Check the condition of the rubber, hopper flashing. Be sure it still seals the hopper to prevent leaking.

If any product comes out of the hopper around the flashing, loosen flashing mounting screws and adjust. Retighten anchor screws and try running the conveyor again. Repeat until no grain is lost.

If the flashing is stuck to the belt, manually peel the flashing up and off the hopper. Replace it if necessary.

10. Inspect the sprockets on the drive wheels, for wearing teeth.
11. Inspect the coupler between the hydraulic drive and the drive box, for wear.
12. Oil hydraulic drive coupler or chain.



Fig 55 - Tension bolts, below drive box

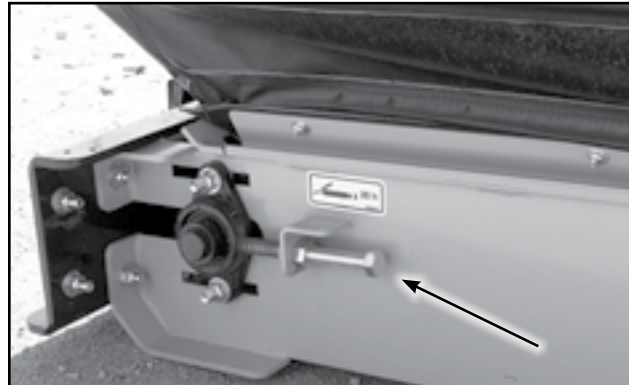

Fig 56 - Adjustment bolt on tail roller

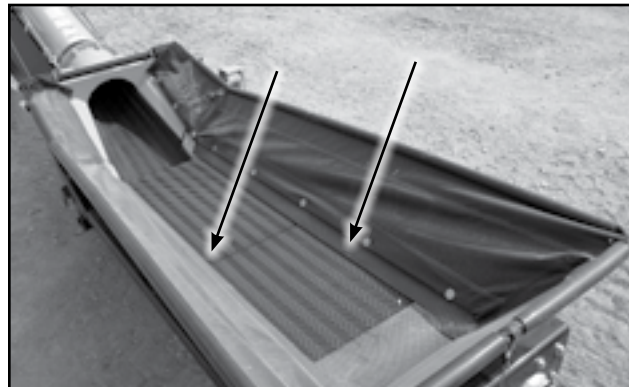

Fig 57 - Hopper flashing

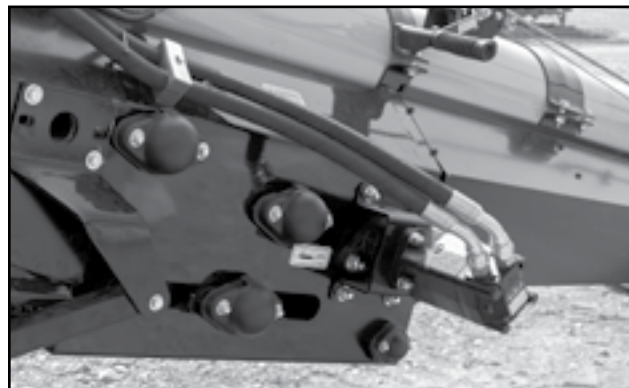

Fig 58 - Conveyor belt drive motor

4.2.3 After 100 Hours or Monthly:

Note:

Recommended greasing is one small stroke every month. Be careful not to over grease as this may push the seal out.

13. Grease hopper roller bearings.



Fig 59 - Tail roller bearing

14. Grease transition roller bearings.



Fig 60 - Transition roller bearings

15. Grease drive box assembly bearings.

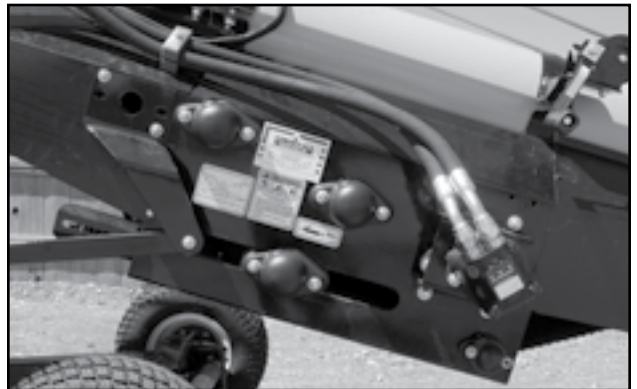

Fig 61 - Drive box roller bearings

16. Grease discharge roller bearings.

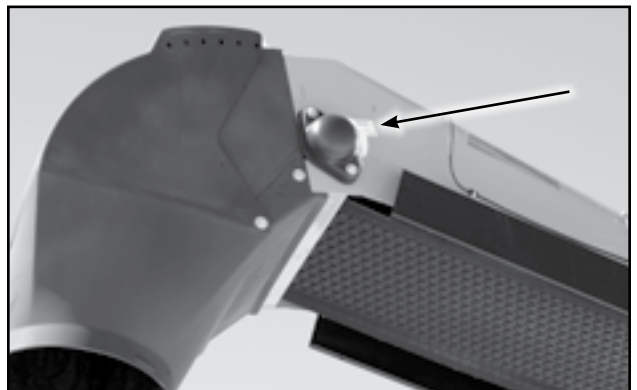

Fig 62 - Discharge roller bearing

4.2.4 After 200 hours or Annually:

17. Refer to the engine manual for specific service and maintenance schedules.
18. Take a hydraulic oil sample and send it to a lab for particle count analysis.
 - Change oil if necessary.
19. Change the hydraulic oil filter.
20. Check that the battery retains its maximum charge.
21. Grease the steering wheel axle bushings and cylinder.



Fig 63 - Hydraulic filter



Fig 64 - Steering wheel axle bushings

22. Grease the steering wheel lift cylinder.



Fig 65 - Hydraulic filter

23. Grease the conveyor lift cylinder.



Fig 66 - Conveyor lift cylinder

24. Grease the upper lift bearings.



Fig 67 - Upper lift bearings

25. Check the tube's straightness, horizontally and vertically.

If adjustment is necessary:

- Take tension off the cables by supporting the tube.

Note:

A thin strap can be fed between the tube and windguard, around the bottom of the tube and out the other side. Then, it can be supported by a winch or forklift.

- Adjust eyebolts at the hopper end.
- Remove support from the tube to view the result of the adjustment.
- Repeat process until the tube is straight.



Fig 68 - Straight conveyor tube

26. Repack the wheel bearings.



Fig 69 - Wheels

27. Wash the entire machine thoroughly using a water hose or pressure washer to remove all dirt, mud, debris or residue.

- Wash the outside.
- Wash around the hopper.
- Leave the belt running while washing inside the tube and around the belt.



Fig 70 - Clean conveyor

4.3 MAINTENANCE PROCEDURES

By following a careful service and maintenance program for your machine, you will enjoy many years of trouble-free service.

Note:

Refer to the engine manual for complete details on your particular model.

⚠ WARNING

ROTATING BELT HAZARD

Turn off engine, lock-out power and wait for all components to stop moving before adjusting the belt.

To check belt position, idle the engine, then rotate the belt slowly.



Fig 71 - Spring tension bolt

4.3.1 Conveyor Belt Tension:

The tension of the belt should be checked weekly, or more often if required, to be sure that it does not slip under load.

The spring tension bolts have yellow washers sandwiched between the bolt and spring.

Reference the tension indicator on the outside of each spring. Line up the yellow washer with the points inside the indicator window. Using these points, the springs will measure 3-3/4" (95 mm).

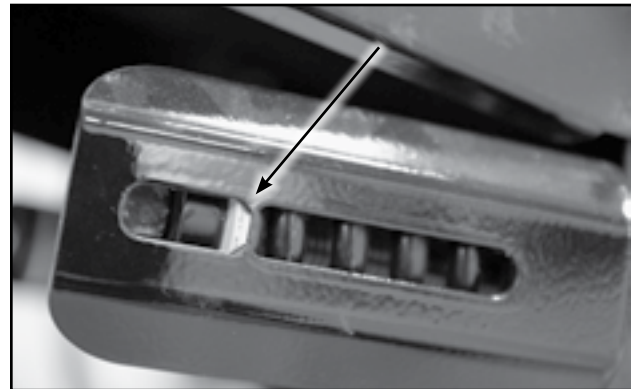

Fig 72 - Tension indicator

Note:

If belt needs more or less slack, stop belt, and turn off engine. Move hopper roller 1/4 to 1/2 inch. Tension the belt at drive box.

IMPORTANT:

If tensioning the belt while it is running, adjust in small increments, alternating between the two bolts often. This will keep the belt aligned.

4.3.2 Conveyor Belt Alignment:**NOTICE****BELT DAMAGE HAZARD**

Alignment of the belt must be checked at the hopper, drive box and discharge. Inspect weekly. Unaligned belt will cause damage and void warranty.

NOTICE**BEARING FAILURE**

If a roller is replaced, ensure both ends are evenly aligned with the frame before running. If not, bearing failure may occur.

The belt is properly aligned when it runs in the centre of all rollers.

Check frequently during the first few minutes of operation with a new belt, and then several times during the first 10 hours.

The new belt normally seats itself during the first 10 hours of operation and can be checked weekly after that.

⚠ WARNING**ROTATING BELT HAZARD**

Idle the engine,
then rotate the belt slowly when checking
the alignment.

Turn off engine when adjusting rollers.

Belt Alignment at Tail and Transition Roller:

1. Rotate the conveyor belt slowly, and check the position of the belt on the tail roller.

Note:

If belt is out of alignment,
it will move to the loose side.

Tighten loose side or loosen tight side.

2. Adjust one side of roller at a time.
 - Loosen bearing housing, then adjust bolt.
3. Tighten the tail roller bearing housing.
4. Rotate the conveyor belt slowly, and check the position of the belt on the hopper roller.
 - Repeat steps until the belt is centred.
5. Replace housing guard.



Fig 73 - Adjustment bolt at tail roller

Belt Alignment inside Drive Box:

If necessary to adjust the position of the belt inside the drive box, use drive roller to make the adjustments.

6. Adjust one side of the drive roller at a time.
 - Loosen the bearing housing, then adjust.
7. Tighten the bearing housing.
8. Run the belt a couple of revolutions and check the alignment.
 - Repeat steps until the belt runs centred.
9. Replace the bearing housing guard.

Belt Alignment at Discharge Roller:

10. If necessary, remove the discharge spout to view the roller.

Note:

If belt is out of alignment,
it will move to the loose side.
Tighten loose side or loosen tight side.

11. Adjust one side of roller at a time.
 - Loosen the bearing housing, then adjust.
12. Tighten the discharge roller bearing housing.
13. Run the belt a couple of revolutions and check the alignment.
 - Repeat steps until the belt runs centred.
14. Replace the bearing housing guard.



Fig 74 - Drive box

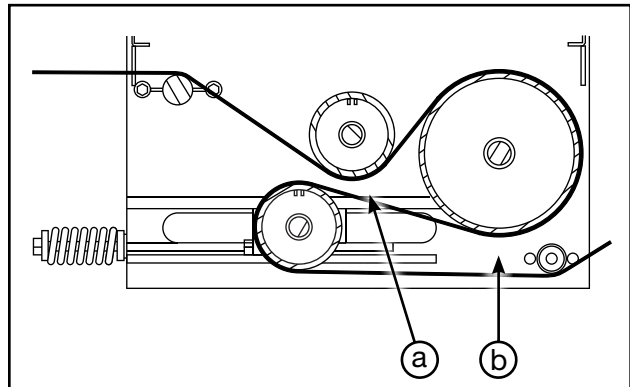

Fig 75 - Drive box; 5" pinch roller (a), 10" drive roller (b)

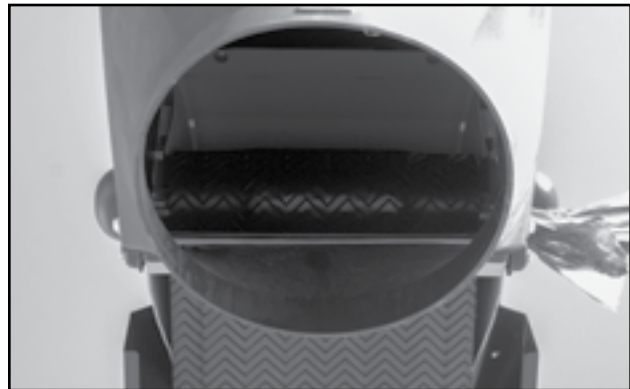

Fig 76 - Inside discharge spout

4.3.3 Conveyor Belt Replacement:

1. Rotate the conveyor belt until the Alligator® lacing is positioned under the tube, inside the wind guard, and is accessible.
2. Rotate the spring tension bolts, at the drive box, to their loosest position.
3. Pull all the slack to the lacing area.
4. Remove the lacing pin and open the belt.
5. Attach the new belt to the end of the old belt which is hanging closest to the hopper.
6. Pull the end of the old belt which is coming from the direction of the discharge spout. The new belt will follow and be threaded into place.
7. Link the ends of the new belt lacing.
8. Push the lacing cable through the lacing to fasten belt.

Note:

A cordless drill can be used to thread the cable.

9. Cut off excess cable.
10. Crimp lacing at both ends to lock cable in place.
11. Cut and taper belt corners, at both ends of lacing.

IMPORTANT:

Taper the belt corners, so they don't catch when running.

12. Set belt tension. Refer to Sections 4.3.1
13. Set the belt alignment.
Refer to Section 4.3.2

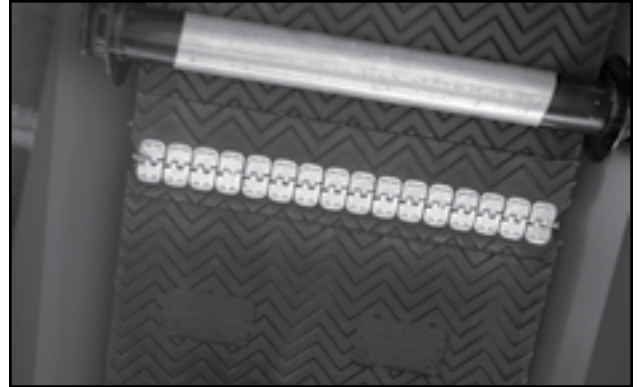

Fig 77 - Conveyor belt lacing

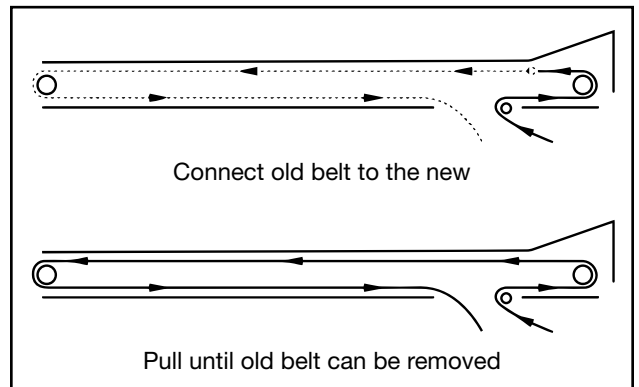

Fig 78 - Threading the belt

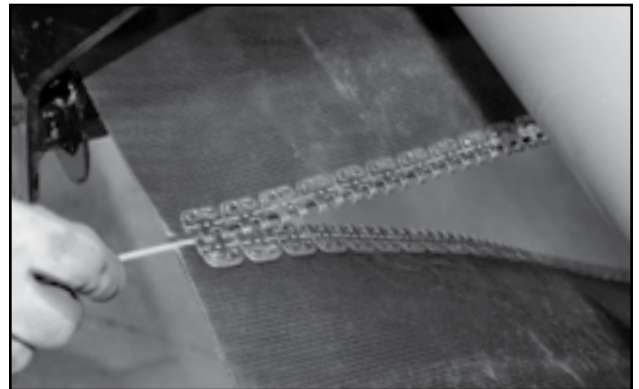

Fig 79 - Thread lacing cable

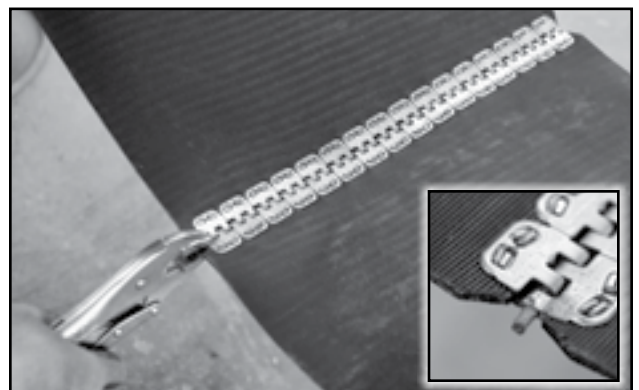

Fig 80 - Crimp lacing and tapered corners

4.3.4 Change Hydraulic Oil:

Use an ISO grade 36 hydraulic oil for all operating conditions (Hydrex MV36 or comparable).

Oil reservoir capacity is: 95 Litres (25 US Gal).

⚠ WARNING**HOT LIQUID HAZARD**

Engine and hydraulics must cool before changing the oil. Hot oil can cause burns if it contacts exposed skin.

IMPORTANT:

Annually, have an oil sample tested for particle count.

Change oil only if necessary.

1. Allow the hydraulics to cool slightly before changing oil.

Note:

It is best to change oil while the engine is warm (not hot) to keep contaminants in suspension.

2. Place a large pan or pail under the drain plug. - Reservoir capacity is 95 Litre (25 US Gal).
3. Remove drain plug and allow to drain for ten minutes.
4. Install and tighten the drain plug.
5. Dispose of the used oil in an approved container and manner.
6. Fill the reservoir with specified oil.

4.3.5 Change Hydraulic Oil Filter:

1. Place a pan under filter to catch any spilled oil.
2. Remove hydraulic oil filter, and dispose of it.
3. Fill the new filter with hydraulic oil.
4. Apply a light coat of oil to the O-ring and install the new filter. Snug up by hand and then tighten another 1/2 turn.
5. Run the engine for 1-2 minutes and check for oil leaks.
6. If leaks are found around the drain plug or filter, tighten slightly.
7. Check oil level. Top up as required.

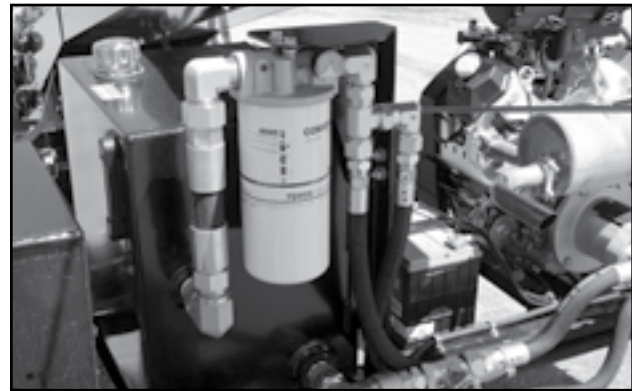
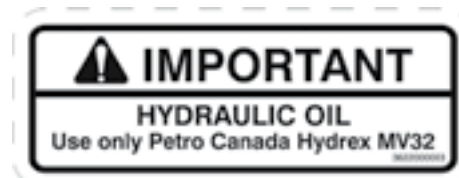

Fig 81 - Hydraulic Oil Filter



3622000003

Fig 82 - Hydraulic oil decal

4.4 SERVICE RECORD

See Section 4.2 for service intervals. This section is only a general guide under good conditions. Under extreme, or unusual circumstances adjust service timing accordingly.

For more detailed schedule pertaining to the specific engine model, consult its Operator Manual.

Copy this page to continue record.

Maintenance	Hours																		
	Serviced By																		
10 Hours or Daily																			
Check Fuel Level																			
Check Hydraulic Oil Level																			
Inspect Conveyor Belt Lacing																			
Inspect Rollers and Bearings																			
50 Hours or Weekly																			
Check Conveyor Belt Tension																			
Check Conveyor Belt Alignment																			
Check Hopper Flashing																			
Inspect Drive Wheels Sprockets																			
Inspect Hydraulic Drive Coupler/Chain																			
Oil Hydraulic Drive Coupler/Chain																			
100 Hours or Monthly																			
Grease Hopper & Transition Roller Bearings																			
Grease Drive Box Roller Bearings																			
Grease Discharge Roller Bearings																			
200 Hours or Annually																			
Change Hydraulic System Oil and Filter																			
Check the Battery																			
Grease Steering Wheel Axle Bushings																			
Grease Steering Wheel Lift Cylinder																			
Grease Conveyor Tube Lift Cylinder																			
Grease Upper Lift Bearings																			
Check Tube Straightness																			
Repack Wheel Bearings																			
Wash Conveyor																			

4.5 ORDERING PARTS

Always give the Model Number and Serial Number when ordering parts.

To get your parts promptly the following information will be required:

- The part name and number
- Your Name, Address, Town, Province/State, Country
- Complete information for shipping

Confirm all phoned in orders in writing. If Purchase Orders are required please note the number on the written order.

Unless claims for shortages or errors are made immediately upon receipt of goods, they will not be considered.

Inspect all goods received immediately upon receipt. When damaged goods are received, insist that a full description of the damage is made with the carrier against the freight bill. If this is insisted upon, full damage can be collected from the transport company.

No responsibility is assumed for delay or damage to merchandise while in transit. Dealers responsibility ceases upon delivery or pickup of shipment from or to the transportation company. Any freight damage claims must be made with the transportation company, not with the dealer.

Section 5: TROUBLESHOOTING

This section contains a list of common problems, causes and offers quick solutions to those issues.

If problems are confronted which are difficult to solve, even after having read through this section, please contact your authorized dealer, distributor or Meridian Manufacturing Inc. Before you call, please have this Operator's Manual and the unit's serial number ready.

Problem

Possible Cause	Possible Solution
-----------------------	--------------------------

Engine won't start

Low battery	Recharge or replace
No fuel	Refuel
Plugged fuel filter	Replace fuel filter
Cold engine	Open choke
Air filter dirty	Clean or replace the air filter

The engine bogs down or is labouring

Not enough power	Open the gate to unload more product. This allows the governor to torque and engage.
Hopper flashing too tight	It will wear in. Adjust to loosen the flashing if still tight after the conveyor has been broken-in.

Conveyor belt doesn't turn or is slipping

Hopper flashing may be stuck to belt, because it is running dry and rubber is heating up	Turn off unit! Manually peel flashing up and off hopper. Then run dry product through to create barrier between flashing and belt
Conveyor belt loose	Tighten and align
Conveyor belt loose because it has stretched	Remove lacing, cut belt shorter and relace
Conveyor belt frozen to tube from operating in high humidity conditions in extreme cold	Remove conveyor from area of high humidity and continue to run empty so the belt dries prior to freezing
No power	Start engine, increase speed to maximum RPM Adjust hydraulic pressure
Seized bearing	Check all bearings, Replace any that are rough or seized
Belt/roller is jammed	Check for sticks, stones, other objects jammed in belt drive area and remove

continued on next page

Conveyor belt doesn't turn or is slipping, continued

Set screw (relief valve) on Dtent control valve on belt drive valve isn't set correctly	IMPORTANT: Do not run hydraulic motor during this adjustment. Sweet spot is to turn the set screw all the way in, then turn back 1-1/2 turns. Turning back/out increases volume of flow, turning in increases pressure.
Hydraulic motor on drive roller may be damaged	Hydraulic motor may need to be replaced

Conveyor belt won't align

Roller lagging may be worn	Replace roller or have it re-lagged
----------------------------	-------------------------------------

Conveyor Belt Fraying

Belt not aligned	Align and adjust tension
------------------	--------------------------

Product leakage

Product may be getting under the belt at the hopper, traveling up inside the belt and leaking off delivery end	Replace hopper flashing
--	-------------------------

Low capacity

Conveyor belt not tight enough	Tighten conveyor belt
Conveyor belt not pinched enough	Inside drive box there is a drive roller and pinch roller. Be sure the belt is snug between both rollers.
Conveyor angle exceeds 30 degrees	Reposition with a lower tube slope

Belt is slowing down

Problem with 2 stage pump	Check flow of the pump. Check pump pressures. Replacement of entire pump may be needed
---------------------------	--

No hydraulic flow

Hydraulic valve closed or plugged	Open hydraulic valve
	Check hydraulic pressures
	Clean or replace hydraulic valve
Hydraulic pressure may be low, check gauge. It should be 1000 - 1200 lb when empty, and in 2000 lb range when loaded.	Check hydraulic pump. Replace if necessary
Hydraulic pump may be damaged	Check hydraulic pump. Replace if necessary

Drive wheels don't work

Wheels may not be engaged	Remove retainer clip and engage drive mechanism
---------------------------	---

Steering axle keeps sinking to the ground

Leak in check valve or cylinder	Replace cartridge in check valve, or replace seals in cylinder
---------------------------------	--

Section 6: REFERENCE

For information not included here, or for a digital copy of this manual, please call your dealer, or Meridian Manufacturing Inc. directly for assistance (1-800-418-9461).

Specifications and measurements are subject to change without notice.

6.1 SPECIFICATIONS

Model	Type of Under-Carriage	Tube Diameter	Belt Width	Axle Width	Transport Height	Transport Length	Gas Power	Diesel Power
1640-TL	A-Frame	10"	16"	8' 4"	9' 7"	43' 9"	40 hp	38.9 hp
1650-TL	A-Frame	10"	16"	8' 4"	11' 5"	53' 7"	40 hp	38.9 hp
1658-TL	A-Frame	10"	16"	8' 4"	12' 10"	60' 8"	40 hp	38.9 hp

Table 1 - Specifications

6.2 WORKING MEASUREMENTS

Model	20°		25°		30°	
	Discharge Height	Length	Discharge Height	Length	Discharge Height	Length
1640-TL	10' 7"	40' 9"	14'	39' 10"	17' 4"	38' 4"
1650-TL	14' 5"	46'	18' 8"	44' 8"	22' 10"	43'
1658-TL	17'	53'	21' 10"	51' 6"	26' 7"	49' 6"

Table 2 - Working Measurements

6.3 BOLT TORQUE

The tables shown below give correct torque values for various bolts and capscrews. Tighten all bolts to the torques specified in chart unless otherwise noted. Check tightness of bolts periodically, using bolt torque chart as a guide. Replace hardware with the same strength bolt.

ENGLISH TORQUE SPECIFICATIONS						
Bolt Diameter "A"	Bolt Torque*					
	SAE 2		SAE 5		SAE 8	
	(Nm)	(ft-lb)	(Nm)	(ft-lb)	(Nm)	(ft-lb)
1/4"	8	6	12	9	17	12
5/16"	13	10	25	19	36	27
3/8"	27	20	45	33	63	45
7/16"	41	30	72	53	100	75
1/2"	61	45	110	80	155	115
9/16"	95	60	155	115	220	165
5/8"	128	95	215	160	305	220
3/4"	225	165	390	290	540	400
7/8"	230	170	570	420	880	650
1"	345	225	850	630	1320	970

Table 3 - English Torque

METRIC TORQUE SPECIFICATIONS				
Bolt Diameter "A"	Bolt Torque*			
	8.8		10.9	
	(Nm)	(ft-lb)	(Nm)	(ft-lb)
M3	0.5	0.4	1.8	1.3
M4	3	2.2	4.5	3.3
M5	6	4	9	7
M6	10	7	15	11
M8	25	18	35	26
M10	50	37	70	52
M12	90	66	125	92
M14	140	103	200	148
M16	225	166	310	229
M20	435	321	610	450
M24	750	553	1050	774
M30	1495	1103	2100	1550
M36	2600	1917	3675	2710

Table 4 - Metric Torque

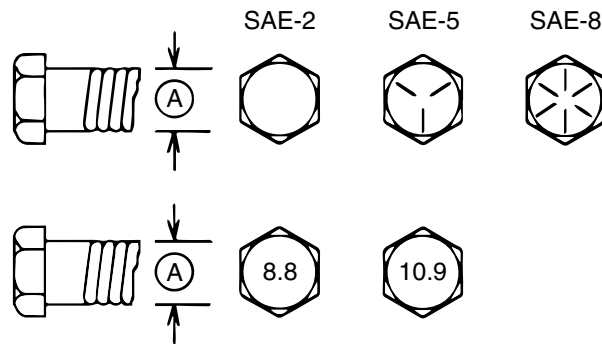

Torque figures indicated above are valid for non-greased or non-oiled threads and heads unless otherwise specified. Therefore, do not grease or oil bolts or capscrews unless otherwise specified in this manual. When using locking elements, increase torque values by 5%.

* Torque value for bolts and capscrews are identified by their head markings.

LIMITED WARRANTY STATEMENT

1. Meridian Manufacturing Inc, hereafter referred to as Meridian®, warrants each new product (the "Goods") to be free from defects in material and workmanship under normal use and service for a period of one (1) year or ninety (90) days in the case of commercial use, from the shipment date from the Meridian dealer (FCA).
2. Meridian® warrants replacement parts and components either manufactured or sold by, will be free from defects in materials or workmanship under normal use and service for thirty (30) days from the shipment date from the Meridian dealer (FCA), or the remainder of the original warranty period on the Goods, whichever is longer.
3. This warranty does not apply to:
 - a. To any merchandise or components thereof, which in the sole and unfettered opinion of Meridian®, have been subject to misuse, unauthorized modifications, alteration, accident, negligence, product abuse or lack of required maintenance.
 - b. If repairs have been made with parts or by persons other than those parts or persons approved by Meridian®.
 - c. To parts and accessories not manufactured by Meridian® including, but not limited to, engines, batteries, tires, belts, PTO shafts or other trade accessories. Such parts shall be covered by the warranty given by the actual manufacturer, if any.
 - d. To failure of parts; or failure of parts to perform due to wear under normal or excessive service conditions; or to failure due to use by the Purchaser for purposes other than originally intended at time of manufacture, including without limitation using the Goods for mixing fertilizer, etc.; or used in excess of the built specifications.
 - e. To Goods used in areas exposed to corrosive or aggressive conditions including, but not limited to, salt water from either inside or outside the Goods.
 - f. To failures or defects arising out of damage during shipment or during storage.
 - g. To materials replaced or repaired under this warranty, except to the extent of the remainder of the applicable warranty.
4. The obligation of Meridian® under this warranty shall not arise unless Meridian® is notified and this warranty is presented together with a written statement specifying the claim or defect within thirty (30) days after the failure is first detected or made known to the Purchaser and within: (i) one (1) year, or ninety (90) days in the case of commercial use; or (ii) thirty (30) days in the case of replacement parts and components manufactured by Meridian®; from the shipment date from the Meridian dealer (FCA). Meridian® in its sole and unfettered discretion shall determine if the claim is valid and whether correction of the defect or failure shall be made by repair or replacement of the materials.
5. Title to any replaced materials Meridian® wishes to have pass to it, shall pass to Meridian®.
6. The obligation of Meridian® hereunder extends only to the original Purchaser or Buyer to whom the Goods were initially sold. This warranty shall not be subject to any assignment or transfer without the written consent of Meridian®.
7. The purchaser acknowledges that it has made its own independent decision to approve the use of the Goods and also the specific fabrication and construction procedures utilized to complete the Goods, and has satisfied itself as to the suitability of these products for its use.

8. This warranty is subject to the following limitations, provisions and conditions:
 - a. Meridian® shall have no liability hereunder for any claims, including field re-work.
 - b. Meridian® shall not be liable for any incidental loss or damage, however caused, including, without limitation, normal wear and tear.
 - c. Meridian® makes no express or implied warranties of any nature whatsoever except for such express warranties as set out herein. The warranty provided herein is in lieu of and excludes all other warranties, guarantees or conditions pertaining to the Goods, written or oral, statutory, express or implied, (except the warranty as to title) including any warranty as to the merchantability or fitness for any particular purpose. Meridian® expressly disclaims all other representations, conditions or warranties, expressed or implied, statutory or otherwise and any representations, warranties or conditions that may arise from a course of dealing or usage of trade. The warranty provided herein shall constitute Meridian's sole obligation and liability and the Purchaser's sole remedy for breach of warranty. No other warranty has been made by any employee, agent, or representative of Meridian® and any statements contained in any other printed material of Meridian® is expressly excluded here from. Meridian® shall not be responsible for any warranty offered by the Purchaser to its customers with respect to the Goods and the Purchaser shall indemnify Meridian® with respect to same if any of those customers makes a claim against Meridian® relating to any such warranty.
 - d. Subject to Meridian's obligations contained in paragraphs 1 and 2 herein, none of Meridian®, its officers, directors, servants or agents shall be liable, or responsible for any loss or damage (including strict liability and liability for loss or damage due to items which the manufacturing processes are designed to identify) whether such loss or damage is caused by negligence in any manner whatsoever (including gross negligence, error, misrepresentation, misstatement, imprudence, lack of skill or lack of judgement).
9. The sole financial obligation of Meridian® under this warranty shall be limited to the repair or replacement of the Goods as originally supplied and in no event shall they exceed the original cost of the Goods supplied.
10. Meridian® shall not have any obligation under any warranty herein until all accounts have been paid in full by the Purchaser.
11. The construction and interpretation of this Warranty shall be governed by the laws of the Province of Manitoba.

WARRANTY CLAIM PROCEDURE

1. The goods must be registered with Meridian®.
2. The purchaser must contact the dealer, from where the unit was purchased, immediately upon discovery of any defects.
3. A completed warranty claim form must be submitted by the dealer to Meridian's warranty representative for review and any subsequent course of action.
 - Warranty claims must be completed with ALL required information in order it to be accepted.
 - Send photographs of the entire piece of equipment, and of the specific area of concern.
4. Warranty repair work will only be performed by Meridian® or an approved representative of Meridian®. No warranty work completed prior to approval by Meridian® will be honoured. Failure to follow procedure may affect any or all of this warranty.
5. All warranty claims will be adjudicated at the sole discretion of Meridian® and in accordance with the terms and conditions of the limited warranty.

This page intentionally left blank

CONVEY-ALL™

(800) 418-9461 | www.convey-all.com | conveyors@convey-all.com